



QAQC LAB

www.qclabequipment.com

X2 Synergy

MA X2.A Moisture Analyzer

MA X2.IC.A Moisture Analyzer

USER MANUAL

IMMU-21-15-06-20-EN



www.radwag.com

Headquarters:

RADWAG Wagi Elektroniczne

Toruńska 5, 26-600 Radom
Phone: +48 (48) 386 60 00,
Service: +48 (48) 386 64 16,
Fax: +48 (48) 385 00 10
radom@radwag.pl
radwag.com

Congratulations and thank you for selecting RADWAG product.
You have purchased a device that has been designed and manufactured to give you years
of service.

Please read this user manual carefully, this shall guarantee reliable operation.

JUNE 2019

CONTENTS

1. GENERAL INFORMATION	7
2. BASIC SAFETY PRECAUTIONS	9
2.1. Warning Symbols and Signals	9
2.1.1. Warning Descriptions	9
2.1.2. Warning Symbols	9
2.2. Precautions	9
2.3. Intended Use.....	11
2.4. Good Weighing Practice	11
2.5. Precautions	12
2.6. Warranty	12
2.7. Supervision over Metrological Parameters	12
2.8. Service Manual Significance	13
2.9. Staff Competence	13
2.10. Protective Clothing	14
3. TRANSPORT AND STORAGE	14
3.1. Delivery Check	14
3.2. Packaging	14
4. UNPACKING AND INSTALLATION.....	14
4.1. Place of Use	14
4.2. Unpacking.....	15
4.3. Levelling	15
4.4. Standard Delivery Components List	15
4.5. Maintenance Activities	16
4.6. Connecting the Moisture Analyzer to the Mains.....	17
4.7. Temperature Stabilization Time.....	18
4.8. Connecting Peripheral Equipment	18
5. START-UP	19
6. OPERATION PANEL	19
7. HOME SCREEN.....	20
7.1. Weighing Result Window	20
7.2. Drying Process Window	21
8. OPERATING THE MENU	22
8.1. Menu Accessing	22
8.2. Screen Scrolling.....	22
8.3. Soft Buttons List	23
8.4. Running Software Functions	23
8.5. Return to Weighing	24
8.6. Buttons, Labels and Text Fields Configuration.....	25
8.6.1. Quick Access Buttons	27
8.6.2. Labels	29
8.6.3. Text Fields.....	31
8.6.4. Bar Graphs	33
9. WEIGHING	34
9.1. Good Weighing Practice	34

9.2. Log In Operation	34
9.3. Units	35
9.4. Weighing Unit Selection	35
9.5. Weighing Units Availability	36
9.6. Start Unit Selection	36
9.7. Custom Units.....	37
9.8. Zeroing	37
9.9. Taring	37
9.10. Weighing Profile.....	39
9.11. <WEIGHING> - Readout Mode Settings	40
9.12. Proximity Sensors	42
9.13. Autotare	42
9.14. Print Mode	43
9.15. Minimum Sample Weight.....	44
9.16. Integration with Titrators	46
10. MISCELLANEOUS PARAMETERS.....	47
11. ADJUSTMENT	49
11.1. Internal Adjustment	49
11.2. External Adjustment.....	50
11.3. User Adjustment	50
11.4. Adjustment Test	50
11.5. Automatic Adjustment	50
11.6. Automatic Adjustment Time.....	50
11.7. Report Printout	51
11.8. Adjustment of the Drying Chamber Temperature	51
11.9. Temperature Test	53
12. PRINTOUTS CONTENT	54
12.1. Adjustment Report	54
12.2. Drying Process Report Printout.....	55
12.3. Other Printouts	58
12.4. Non-standard printouts	60
12.4.1. Inserting Texts.....	60
12.5. Variables	63
13. WORKING MODES – General Information	64
13.1. Working Modes Availability	64
13.2. Running Working Mode	64
13.3. Working Mode Parameters.....	65
14. DATABASES.....	65
14.1. Database Connected Operations.....	65
14.2. Products	67
14.3. Operators	67
14.4. Packaging	67
14.5. Customers	67
14.6. Drying Programs	68
14.7. Drying Process Reports	68
14.8. Ambient Conditions	68
14.9. Weighings.....	69

15. SAMPLES PREPARATION	70
15.1. Moisture Content Measurement Principle for Moisture Analyzer	70
15.2. Sampling and Preparation	70
16. SELECTION OF DRYING PROCESS PARAMETERS	72
16.1. Optimum Sample Mass	72
16.2. Influence of Sample Mass on Measurement Repeatability	73
16.3. Drying Temperature	73
16.4. Drying Profile Selection	73
16.5. Drying Time	74
16.6. Drying Profile Analysis	74
17. DRYING	75
17.1. Safety Precautions During Drying	75
17.2. Mode Related Settings	76
17.3. Drying – Quick Access Buttons	77
18. DRYING PROCESS PERFORMED BY MEANS OF QUICK MENU	77
18.1. Drying Profile and Drying Process Parameters	78
18.2. Finish Mode	79
18.3. Unit of a Displayed and Printed Result	80
18.4. Printout Interval	80
18.5. Drying Process Wizard	81
19. DRYING PROCESS USING DRYING PROGRAMS DATABASE	82
20. DRYING PROCESS	83
20.1. End Result Prognosis	88
21. COMMUNICATION	91
21.1. RS232	91
21.2. ETHERNET Settings	91
21.3. Wi-Fi Settings	91
21.4. USB Ports	94
22. PERIPHERALS	97
22.1. Computer	97
22.2. Printer	99
22.3. Record of Measurement Data Onto a USB Flash Drive	102
22.4. Barcode Scanner	103
22.5. Ambient Conditions Module	103
23. AMBIENT CONDITIONS	103
24. COMMUNICATION PROTOCOL	106
24.1. List of Commands	106
24.2. Response Format	107
24.3. Manual Printout / Automatic Printout	122
25. PERIPHERAL DEVICES	123
26. ERROR MESSAGES	123
27. MOISTURE ANALYZER MEANS OF OPERATION	124
28. MAINTENANCE ACTIVITIES	124
28.1. Cleaning Moisture Analyzer Components	124
28.2. Cleaning Temperature Sensor	125

28.3. Troubleshooting	125
29. ACCESSORIES	126
30. MOISTURE ANALYZER INFO	126

1. GENERAL INFORMATION

Dimensions:

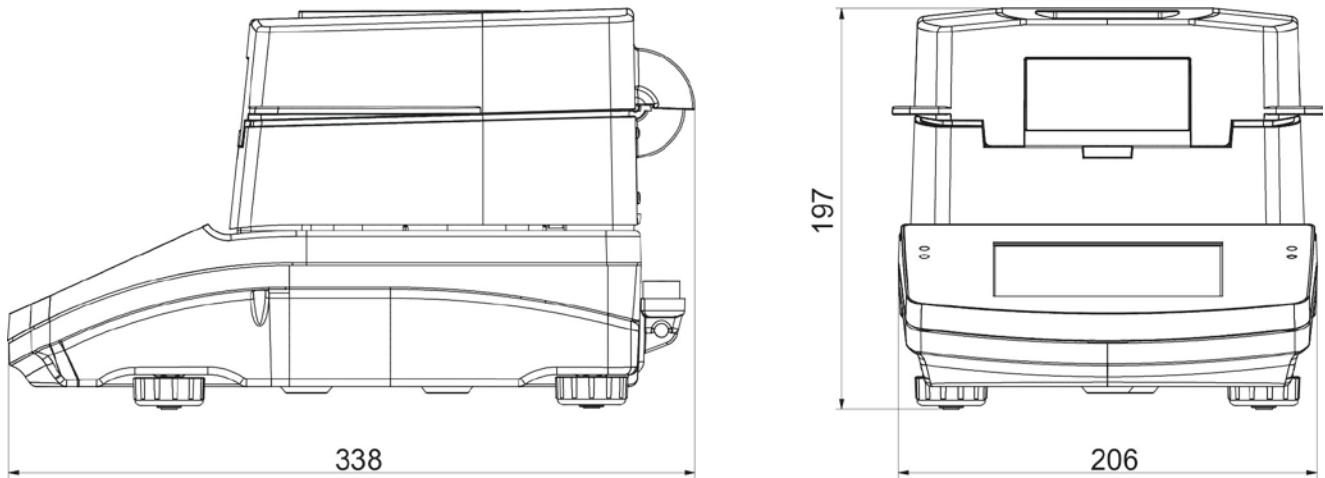

Connectors:

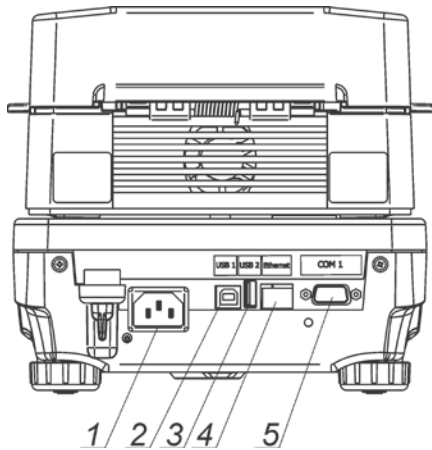

1. power supply connector
2. USB 2 type B connector
3. USB 1 type A connector
4. ETHERNET connector
5. COM connector

Diagrams of connection cables:

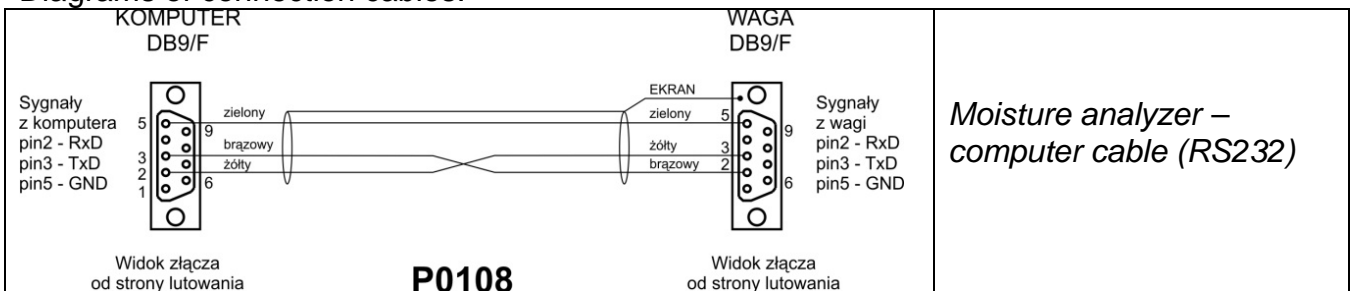

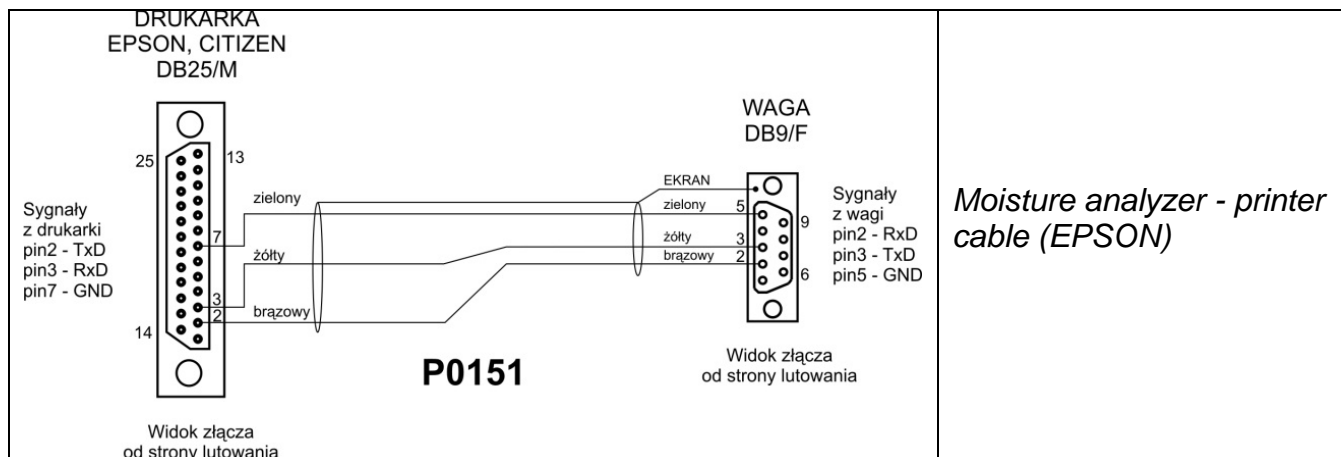

TECHNICAL SPECIFICATIONS

Moisture analyzer type	MA 50/1.X2.A	MA 50.X2.A	MA 110.X.A	MA 210.X2.A
	MA 50/1.X2.IC.A	MA 50.X2.IC.A	MA 110.X.IC.A	MA 210.X2.IC.A
Max capacity	50 g	50 g	110 g	210 g
Reading unit	0.1 mg	1 mg	1 mg	1 mg
Tare range	- 50 g	- 50 g	- 110 g	- 210 g
Maximum sample weight	50 g	50 g	110 g	210 g
Moisture content readability	0.0001%	0.001 %		
Moisture content repeatability	+/- 0.05% (sample ~2g), +/- 0.01% (sample ~10g)			
Drying temperature range	Max. 160 °C Max. 250 °C (WH)			
Heating module	IR emitter (NP) halogen lamp (NH or WH) metal heater (NS)			
Drying method	4 drying profiles: standard, fast, step, mild			
Finish mode	3 modes: automatic, time-defined, manual			
Operating temperature	+10 °C - +40 °C			
Power supply	230V 50Hz AC			
Display	5" colour capacitive touch screen			
Weighing pan dimensions	ø 90 mm, h = 8 mm			
Drying chamber dimensions	120 x 120 x 20 mm			
Net/gross weight	~4.9 / 6.4 kg			
Packaging dimensions	470x380x336 mm			
Power consumption	6W during weighing max 450W during drying			
Ingress protection	IP 41			

All moisture analyzers are equipped with auto opened/closed drying chamber lid. Moisture analyzers of MA xx.X2.IC.A series are additionally equipped with mechanism of auto adjustment.

2. BASIC SAFETY PRECAUTIONS

2.1. Warning Symbols and Signals

Safety precautions are marked with special descriptions and warning signs. They inform and warn an operator of possible dangers.

Ignoring the safety warnings may cause injuries, damage of the moisture analyzer, its inappropriate operation and errors of measurements.

2.1.1. Warning Descriptions

WARNING Medium risk danger that can lead to a serious injury or death.

CAUTION Low risk danger that can lead to moisture analyzer damage or dysfunction, loss of data or minor or moderate injury.

NOTE Critical information on the moisture analyzer.

2.1.2. Warning Symbols



Electrocution



Acid/Corrosion



Potential danger



Flammable or explosive substances



Toxic substances



Hot surface



Hand injury

2.2. Precautions

WARNING!

The use of the moisture analyzer regardless of both, safety information and service manual guidelines may cause health damage and even death.



WARNING:

Nominal voltage for a moisture analyzer is 230V AC. It means that safety usage precautions for low voltage devices must be abide by while operating the device. Three-core power supply cable with grounding pin comes standard with a moisture analyzer. If necessary, an extension cord can be used as long as it meets the applicable standards and has a protective ground conductor. Intended disconnection of the grounding cable is forbidden.

Voltage range for moisture analyzers marked with AC 230V symbol: 220

V-240 V, 50/60 Hz,



CAUTION:

Drying chamber cannot be opened during operation (drying process). It is due to the fact that a halogen lamp and its glass shield may reach the temperature of up to 400°C.

When setting up the moisture analyzer leave enough space to prevent heat from building up and to keep your analyzer from overheating. Leave about 20 cm around the instrument and about 1 m above.

Air vents that are located in the housing cannot be covered, sealed or blocked in any other way.

Do not put any flammable substances on, under or near the moisture analyzer.

Be particularly careful when removing the sample from the drying chamber. The sample itself, the drying chamber, shields and the weighing pan can still be extremely hot.

In case of any maintenance work (cleaning the inside of the drying chamber), the moisture analyzer must be switched off.

Wait until all the components have cooled down.

Do not perform any modification to the heating module.

Same types of samples require taking particular safety precautions.

They can pose a danger for people and objects. It is always the user who is liable for possible damages caused by the use of an inappropriate sample.



CAUTION:

Corrosion Substances that release aggressive vapours (e.g. acids) during the heating process. In this case, it is recommended to work with small samples. Otherwise, vapours can condense on cold housing parts and cause corrosion.



WARNING:

Fire or explosion Flammable or explosive substances, substances containing solvents or releasing flammable or explosive gases or vapours. Perform a risk analysis when in doubt relating to the sample characteristics before carrying out the procedure. For this type of samples apply the drying temperatures as low as possible to prevent flames or explosion. During the analysis it is necessary to wear protective glasses and gloves. The samples should be relatively small.

Under no circumstances can the instrument be left unsupervised!



WARNING:

Substances containing toxic and caustic or corrosive components

Substances that release toxic gases or vapours can cause irritations (eyes, skin or respiratory system), illnesses or even death. Dry such substances only in fume cupboards.

**WARNING:**

Moisture analyzers are equipped with a mechanism for closing and opening the drying chamber lid. Be extremely careful while operating the device so as to prevent potential injury during lid closing/opening.

**WARNING:**

If there are any symptoms of combustion (smoke, combustion noise, flame), turn off the device, wait 10 minutes and open the chamber after the described phenomena no longer occur. If they continue or there is a suspicion that they continue to occur, wait another 10 minutes. If the phenomenon intensifies or persists and it is impossible to stop it, disconnect the device from the mains immediately and follow the applicable fire regulations.

**WARNING:**

Any dangerous phenomena occurring in the device must be immediately reported to RADWAG service points.

Under no circumstances should the instrument be used in an area with any risk of explosion.

The moisture analyzer is not designed to operate in hazardous areas.

2.3. Intended Use

The moisture analyzer of MA X2 series is designed to determine: relative moisture content in small samples of various substances, dry mass content in small samples and mass of weighed objects.

The moisture analyzer ensures fast and precise determination of sample's moisture content.

With use of a graphic touch screen the operation and measurement is simplified. A moisture analyzer can be used to determine moisture content of different materials. At the initial stage of measurement, the device precisely determines the mass of an object placed on instrument's weighing pan. As the mass reading is stabilized, the sample is quickly heated by a halogen lamp, an IR emitter or a metal heater causing humidity evaporation from the tested sample. While sampling, the moisture analyzer is continuously checking the loss of mass, and on calculation, it displays current moisture content in a tested sample.

Compared to conventional methods of humidity content determination of various substances, application of moisture analyzer considerably shortens measurement time and simplifies testing procedure.

MA X2 moisture analyzer allows setting multiple parameters which influence the procedure of moisture content determination in a sample, such as: temperature, time, drying modes, etc.

2.4. Good Weighing Practice

CAUTION!

Do not open the drying chamber during drying process. Moisture analyzer features a halogen lamp which is a very powerful heat source. Thus, operator should pay special

attention no to touch those elements of a moisture analyzer that get hot while drying procedure (i.e.: disposable pan, pan handle, and inner shields of the drying chamber). Remember that some of tested samples may become dangerous if heated (appearance of poisoning vapours, danger of ignition or explosion).

MA X2 moisture analyzer is not intended for dynamic weighing. Even if small amounts of a sample are added to or taken off the weighing pan, the mass readout should only be taken on stabilization of measurement result (upon displaying ▲▲ pictogram).

Do not place any magnetic materials on the weighing pan. This can cause damage of the measuring system of the instrument.

Be sure to avoid impact shock and overloading the moisture analyzer in excess of the prescribed maximum measuring range (max capacity), minus any possible tare weight that has been applied.

Never use the moisture analyzer in an environment endangered by explosion!

This moisture analyzer is not adjusted for operation in explosive areas.

There must not be any modification made to the moisture analyzer.

2.5. Precautions

RADWAG moisture analyzer adheres to all binding safety regulations. Nevertheless there are exceptional circumstances that may cause danger.

Do not open the instrument's housing. Inside there are no parts that would require maintenance, repair or replacement carried out by an operator. In case of any problems, contact RADWAG service or a distributor.

Use the device only as intended. Follow this user manual in terms of installation and configuration of the device.

Since use of the moisture analyzer conversely to safety precautions and service manual guidelines may be hazardous to operator's health and life, it is obligatory to read them carefully:

- Use the moisture analyzer to determine humidity content in samples and to determine mass of a tested sample; any other use of the moisture analyzer may be dangerous both to the device and the operator,
- Before commissioning the moisture analyzer, make sure that the nominal power of the device specified on its data plate is compatible with the supply in the mains to which the moisture analyzer is to be plugged in,
- **Halogen lamp and IR emitter can only be changed by an authorized service employee,**
- Protect moisture analyzer against contacts with liquids, it might lead to electrocution, fire, emission of substances containing toxic or caustic vapour, emission of explosive substances.

2.6. Warranty

The warranty does not cover:

- defects being an effect of not respecting service manual guidelines,
- using the moisture analyzer conversely to its intended use,
- any modifications of a moisture analyzer or cases when its housing has been opened (damaged protective stickers),
- mechanical defects or defects caused by liquids, water and natural wear,
- defects caused by inappropriate setting or by electrical wiring failures,
- overloading of the measuring mechanism.

2.7. Supervision over Metrological Parameters

Metrological parameters need to be checked in determined time intervals. Inspection frequency is conditioned by ambient conditions in which the moisture analyzer is used, kind of carried out processes and adopted quality management system.

2.8. Service Manual Significance

It is very important to read the service manual carefully before switching on and starting up moisture analyzer operation, even if you are experienced and have worked with this type of instrument before.

2.9. Staff Competence

The moisture analyzer should be utilized and supervised only by users who are trained and experienced in such type of instruments.

In order to use the moisture analyzer, first read the service manual. Keep these instructions for the future reference.

Do not make any design modifications. Additional equipment compatible with the moisture analyzer and spare parts should be supplied by RADWAG or an authorized distributor.

2.10. Protective Clothing

While working with the instrument use protective clothing, this is to take safety precautions against potential hazards source of which might be tested samples and ingredients.

Use the following while carrying out tests:

- protective apron,
- protective glasses,
- protective gloves (while working with hazardous chemical substances).

Before the use of the above-mentioned protective clothing, make sure that it has been designed to be used with specific samples and that it is not damaged.

3. TRANSPORT AND STORAGE

3.1. Delivery Check

Upon delivery it is necessary to check the package and the device, make sure that your package bears no signs of damage.

3.2. Packaging

Keep all package elements should your device be transported in the future. Remember that only original packaging can be used for shipping purposes. Prior packing, uncouple any cables, remove any separable components (weighing pan, shields, inserts). The device components must be packed into an original packaging providing protection against potential damage during transportation.

4. UNPACKING AND INSTALLATION

4.1. Place of Use

- Operate the device in a workroom free of vibrations and shakes, where there are no air drafts nor dust. The workstation has to be located up to 2000 m above sea level.
- When setting up the moisture analyzer leave enough space to prevent heat from building up and to keep your analyzer from overheating. Leave about 20 cm around the instrument and about 1 m above.
- Make sure that the ambient temperature ranges between: $+10^{\circ}\text{C} \div +40^{\circ}\text{C}$.
- Relative humidity cannot exceed 80% at the temperature of 31°C , decreasing linearly to 50% of the relative humidity at the temperature of 40°C .
- Place the moisture analyzer either on a robust-design table or on a wall bracket, which is both distant from heat sources and insusceptible to vibrations.
- Make sure that the moisture analyzer's power supply plug is easily accessed and can be quickly disconnected from the mains if necessary.
- Take special precaution while weighing magnetic objects, as part of the moisture analyzer is a strong magnet.

4.2. Unpacking

Carefully take the device out of the packaging, remove the transport lock and gently place the moisture analyzer at its workplace. Install the components, follow the diagram:

Install:

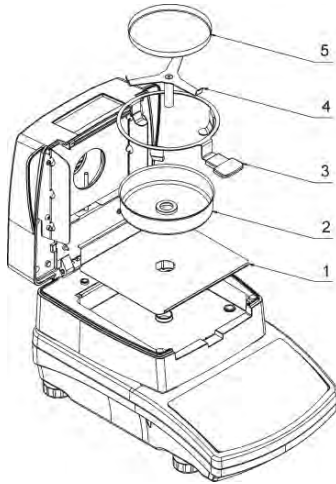

- drying chamber base insert (1),
- draft shield (2)
- weighing pan handle (3),
- weighing pan cross-shaped holder (4),
- disposable pan (5).

Positioning the cross-shaped holder:

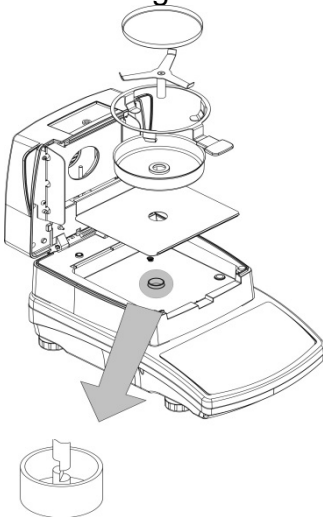

When installing the cross-shaped holder (pan supporter) pay special attention to the correct positioning of its mandrel. The mandrel features a cut providing unique positioning of the holder against the pan handle, thus preventing their contact and friction.

Positioning the cross-shaped holder:

- assemble the holder onto the mandrel and turn it slightly so that the mandrel cuts are located in their unique and correct position,
- turn the mandrel gently so as not to damage moisture analyzer's measuring system.

4.3. Levelling



It is necessary to level the instrument prior connecting it to the mains. To level the moisture analyzer turn its feet until an air bubble takes central position.

4.4. Standard Delivery Components List

- Moisture analyzer.
- Drying chamber base insert
- Drying chamber shield.
- Weighing pan handle
- Cross-shaped holder
- Disposable pan
- Power cord
- User manual - CD version.

4.5. Maintenance Activities

Maintenance activities:

1. Disassemble the weighing pan and other detachable components (the components differ depending on the weighing instrument model, read section: *UNPACKING AND INSTALLATION*). Be careful while installing the components so as not to cause any damage to the moisture analyzer mechanism.
2. In order to ease cleaning of glass anti-draft chamber panes, it is permissible to remove them following the below instruction.

Caution:

In case of heavy dust occurring at the place of moisture analyzer operation, it is recommended to commission an inspection of the device to be carried out by RADWAG service every 6 months.

Cleaning the weighing pan while still installed may cause damage of the measuring system.

Cleaning ABS components:

To clean dry surfaces and avoid smudging, use clean non-colouring cloths made of cellulose or cotton. You can use a solution of water and detergent (soap, dishwashing detergent, glass cleaner). Gently rub the cleaned surface and let it dry. Repeat cleaning process if needed.

In the case of hard to remove contamination, e.g. residues of adhesive, rubber, resin, polyurethane foam etc., you can use a special cleaning agents based on a mixture of aliphatic hydrocarbons that do not dissolve plastics. Before using the cleanser for all surfaces we recommend carrying out tests. Do not use cleansers containing abrasive substances.

Cleaning anti-draft chamber panes:

Select dissolvent depending on a dirt. Never soak the glass panes in alkaline solutions since they interact with glass and may cause damage. Do not use cleansers containing abrasive substances.

For organic dirt use acetone first, next use water or detergent. For other than organic dirt use diluted acid solutions (soluble salts of hydrochloric or nitric acid) or base solutions (ammonium or sodium base).

To remove ACIDS use protophilic solvent (sodium carbonate), to remove BASE use protogenic solvent (mineral acid of various concentration).

In case of heavy contamination use brush and detergent, nevertheless avoid detergents containing large and hard molecules which could potentially scratch glass panes.

At the end of the cleaning process rinse the pane using distilled water.

Use soft brush with wooden or plastic handle exclusively in order to avoid risk of scratches. Do not use wire brush.

Rinsing is a necessary cleaning process stage allowing to remove remaining soap, detergents and other cleansers from the panes prior their reinstallation.

After preliminary cleaning process stage, rinse the pane using running water first, distilled next.

Avoid drying the panes either using paper towel or forced air circulation since some fibres, grains or contamination of other type could permeate into the panes thus causing weighing errors.

We do not recommend using driers when drying measuring glass tools.

It is a frequent treatment to leave glass components on a rack to dry.

Cleaning stainless steel components:

Avoid using cleansers containing any corrosive chemicals, e.g. bleach (including chlorine). Do not use cleansers containing abrasive substances. Always remove the dirt using microfiber cloth to avoid damage of protective coating.

In case of a daily maintenance:

- 1. Remove the dirt using cloth dipped in warm water.*
- 2. For best results, add a little bit of dishwashing detergent.*

Cleaning powder-coated components:

For preliminary cleaning process stage you need running water or wet sponge featuring large holes, this will help you to remove loose, heavy dirt.

Do not use cleansers containing abrasive substances.

Next, using cloth and cleanser-water solution (soap, dishwashing liquid) gently rub the cleaned surface.

Avoid using cleanser without water since it may result with damage of the cleaned surface, please mind that large amount of water mixed with cleanser is a must.

Cleaning Aluminium Components

While cleaning aluminium components use products acid by nature, e.g. spirit vinegar, lemon. Do not use cleansers containing abrasive substances. Avoid using hard brush, this may cause scratches. It is recommended to use microfibre cloth.

While polishing the surface use circular movements. Use clean, dry cloth to make the surface shine.

4.6. Connecting the Moisture Analyzer to the Mains

The moisture analyzer can be plugged to the mains only by means of an original power cord, which comes standard with the instrument. Rated voltage (specified on the device's data plate) must be compatible with the mains rated voltage.

Make sure that the moisture analyzer's power supply plug is easily accessed and can be quickly disconnected from the mains if necessary.

The power cord can be connected only to a socket with a ground contact. Plug the power cord to the moisture analyzer. The moisture analyzer's power plug is located at the back of its housing.

Moisture analyzer display shows name and software number first, next an indication 0.000 g (moisture analyzers with readability of 1 mg) or 0.0000 g (moisture analyzers with readability of 0.1 mg). If the indication is different than zero, press →0← key.

4.7. Temperature Stabilization Time

Before start of the measuring processes, it is necessary to wait until the moisture analyzer reaches thermal stabilisation.

Moisture analyzer stored in much lower temperatures, than the workroom temperature, before being plugged to the mains (e.g. during winter period) must be subjected to thermal stabilisation. The thermal stabilisation period takes about 4 hours. During the thermal stabilization, the indications on the screen can change. Potential workroom temperature change shall occur gradually and slowly in the course of the weighing instrument operation.

4.8. Connecting Peripheral Equipment

CAUTION:

It is possible to connect only SELV (Safety Extra-Low Voltage) and limited Energy devices to the moisture analyzer interfaces.







Use only accessories and peripheral equipment recommended by the manufacturer. The moisture analyzer must be disconnected from the mains before connecting or disconnecting any peripherals (printer, PC computer, computer keyboard of USB type, additional display). Upon connecting the peripherals, plug the moisture analyzer to the mains.

5. START-UP

- Plug the power adapter to a socket, next connect the connector to port located at the back of the housing.
- Press  key located in the top right hand corner of the panel.
- Upon completed start-up, the home screen is displayed automatically.
- The moisture analyzer runs with no operator logged in. In order to start operation it is necessary to carry out logging procedure (for detailed logging procedure read later sections of this service manual).

6. OPERATION PANEL



Key	Description
	Press to switch the moisture analyzer ON/OFF
	Press to zero the moisture analyzer
	Press to tare the moisture analyzer
	Press to confirm modifications/ to send the weighing result to a printer or a computer
	Function key <Esc>, press to abort parameter modifications or exit to previous menu level
	Function key <Home>, press to exit to home screen
	Programmable proximity sensors, press to enable operation of freely selected functions

7. HOME SCREEN

7.1. Weighing Result Window

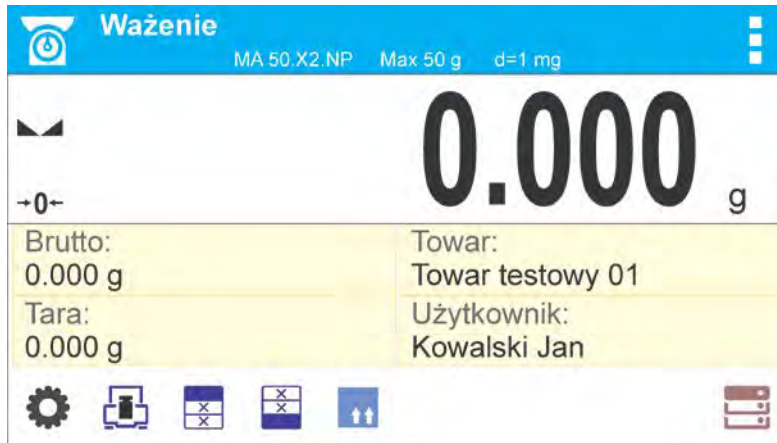

The home screen can be divided into 3 sections:

- Top section displaying data on active working mode (pictogram and name), metrologically important data and button enabling selection of functions available for a particular working mode:



The top bar displays the following information:

	Working mode name and symbol.
	Symbol informing that wireless communication is on.
	Symbol informing that communication with a USB flash drive is on.
	Symbol informing that PC keyboard is connected.
	Symbol informing that printer is connected via USB.
	Symbol informing that communication with a PC computer is on.
	Symbol informing that data is saved to moisture analyzer memory.
	Symbol informing that the moisture analyzer connects with E2R system.
	Symbol informing that the weighing profile is active.

- Section presenting the weighing result:

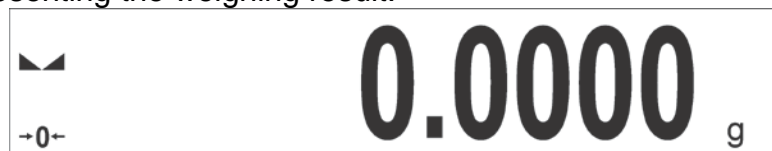

- Section comprising supplementary information on currently performed operations, and function buttons:



Caution:

Data and buttons contained in the workspace are freely configurable.
For detailed instruction read section 8 of this user manual.

7.2. Drying Process Window



The home screen can be divided into 3 sections:

- Top section displaying data on active working mode (pictogram and name), metrologically important data and button enabling selection of functions available for a particular working mode:



- Section presenting the weighing result:



- Section comprising supplementary information on currently performed operations, and function buttons:

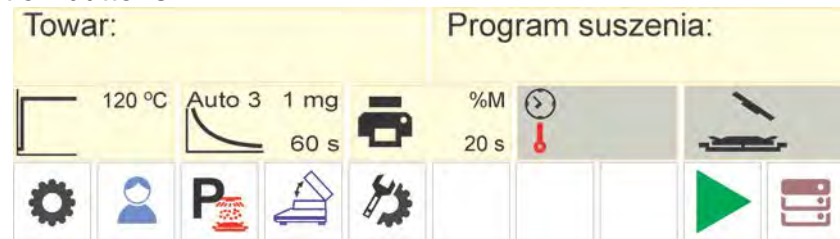

Caution:

Data and buttons contained in the workspace are freely configurable.
For detailed instruction read section 8 of this user manual.

8. OPERATING THE MENU

Operation of moisture analyzer program menu is intuitive. The touch screen makes the software operation easy. Pressing a function button or an area on the display initiates an assigned function or process.

8.1. Menu Accessing

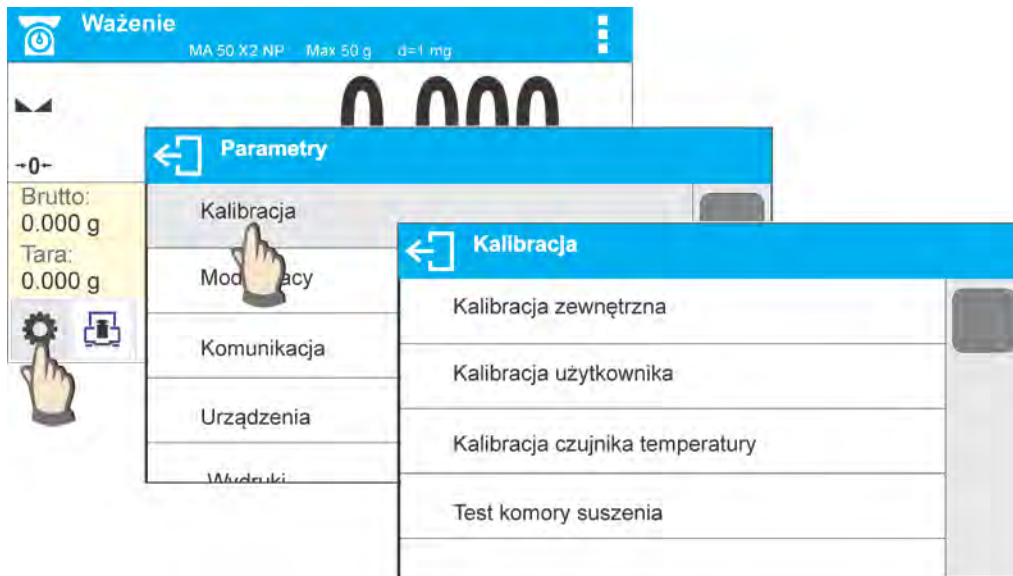





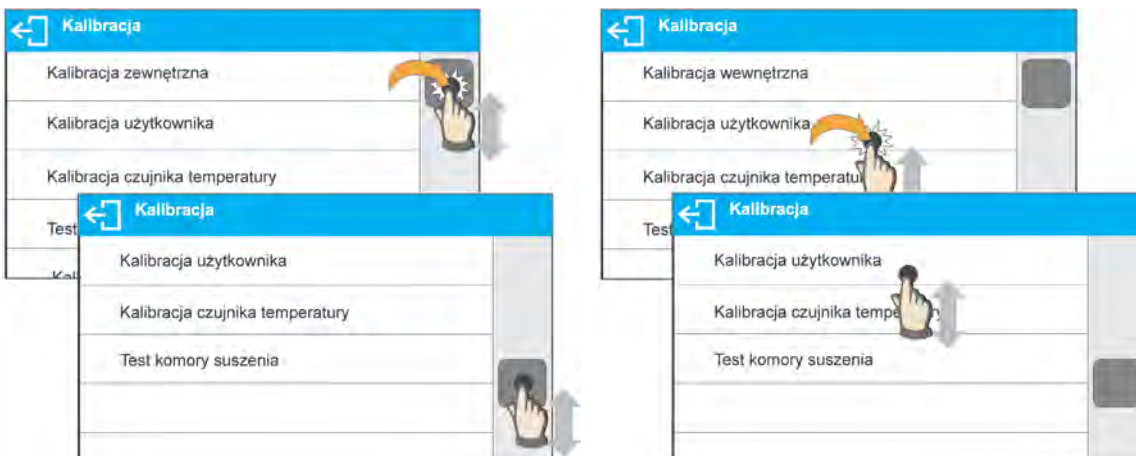









In order to enter moisture analyzer menu press  <PARAMETERS> entry. Pressing any button comprised within workspace or pressing parameter name results with change of colour. If a given area has any function or action assigned, then it is performed automatically upon pressing (e.g. adjustment procedure), respectively a particular window with parameters or a list of appropriate settings is displayed.

8.2. Screen Scrolling



There are two methods for scrolling the screen of parameters window. The first one requires pressing, holding down and scrolling up or down the scrollbar located on the right. The second one requires pressing, holding down and scrolling up or down any point of the displayed window.

8.3. Soft Buttons List

	Press to enter home screen.		Press to clear edit box content.
	Press to scroll the menu up or down.		Press to switch the on-screen keyboard on/off.
	Press to confirm the introduced modifications.		Press to export database (active upon connecting a USB flash drive)
	Press to exit, parameter remains unmodified.		Press to import database (active upon connecting a USB flash drive)
	Press to add database record.		Press to search particular database entry by name.
	Press to print database entries.		Press to search particular database entry by code.
	Press to move (exit) one level up		Press to delete database entries.

8.4. Running Software Functions

- Quick access button:



Press to enter parameters settings.

- Label:

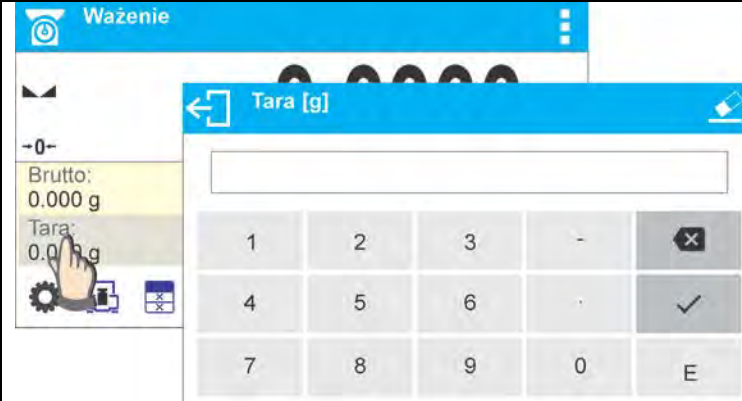

Press to enter tare value.

- Text field with function assigned:

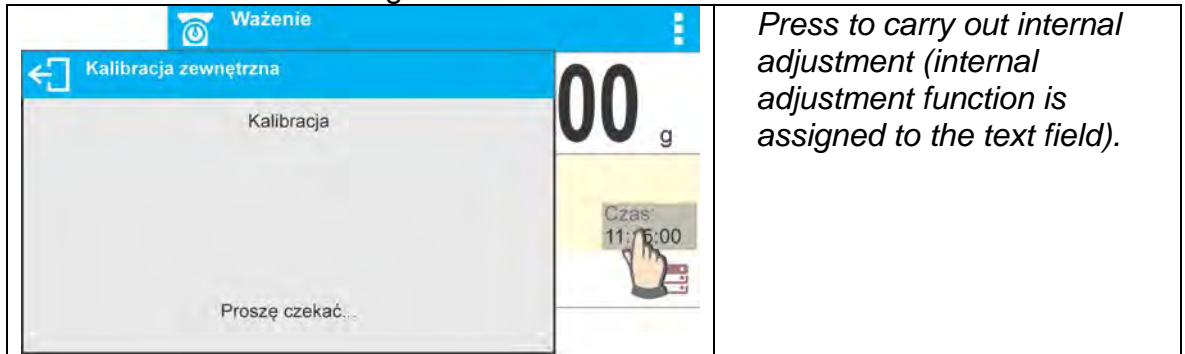

- Working mode functions:

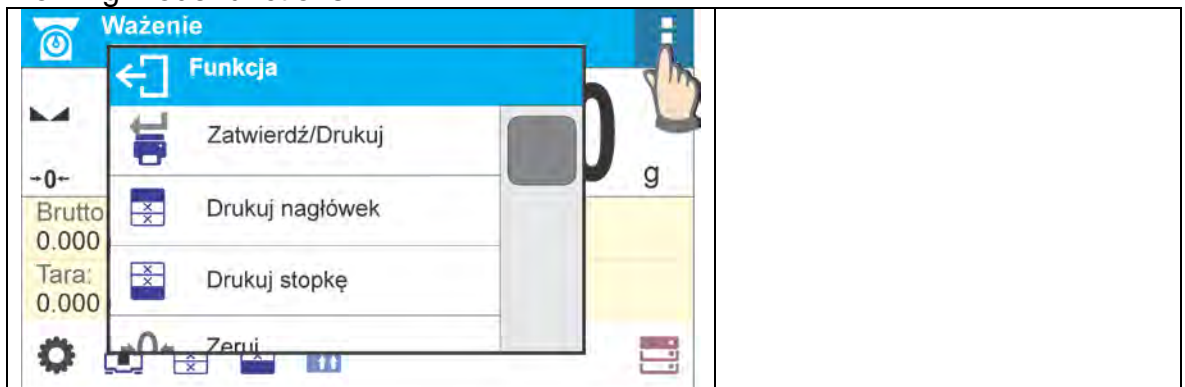

Caution:

For instruction of buttons, labels and text fields configuration refer to section 8.6 of this user manual.

8.5. Return to Weighing

Modifications introduced into moisture analyzer memory, are automatically saved upon return to weighing operation.

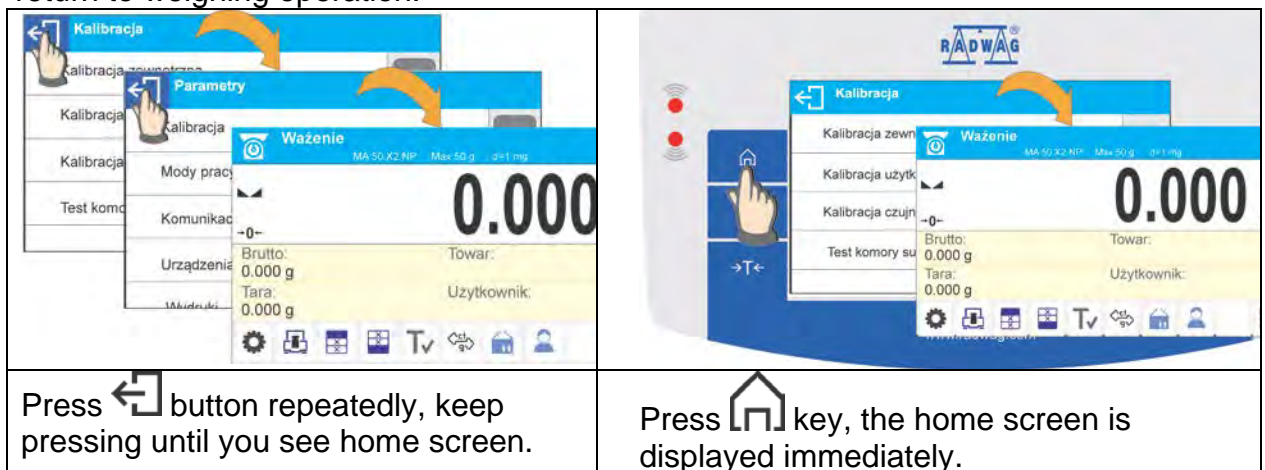

8.6. Buttons, Labels and Text Fields Configuration

Area below mass indication section can be freely customized. The area has a form of a table: 3 rows, 10 columns:



The division lines presented above are not visible on the moisture analyzer screen, they are for information purposes only.

This section is designed to comprise widgets: buttons, labels, text fields, bar graphs:

- **button** – pictogram to which a particular function is assigned, the function is triggered upon pressing the pictogram;
- **label** – field for information, its content is stable. The content depends on displayed option, wherein the options change in course of moisture analyzer operation. The label may be active or passive. Active label, when pressed, triggers function that is assigned to it, e.g. selecting product out of products database. Passive label provides you with information on current state, no function is assigned to it;
- **text field** - field for information, both content (text and variables of line 1 and 2) and function assigned to text field are programmable. The text field may be active or passive. The operator determines the function assigned to the text field. The function does not have to refer to the displayed information e.g. the text field displaying date and time may trigger moisture analyzer calibration upon being pressed;
- **bar graph** – available for CHECKWEIGHING and DOSING modes. Field providing information on Min and Max threshold (DOSING) or target mass (DOSING). The information is presented in a graphic form, bar graph colour informs whether weight stays within the specified tolerance or is out of it.

Each working mode features default home screen widgets set. You can customize the screen.

Configuration procedure:

1. Widgets dimensions (width x height)
 - Button – 1x1; 2x2
 - Label – 2x1; 3x1; 4x1; 5x1
 - Text field - 2x1; 3x1; 4x1; 5x1; 6x1; 7x1; 8x1; 9x1; 10x1
 - Bar graph – 5x1; 10x1

To quickly restore the default widgets layout press the widget and hold it until a window with available options displays. Select **<Default screen settings>** entry and confirm.

Exemplary arrangement of widgets:



2. Always press extreme left side of a particular field that is to hold a selected <Widget>.

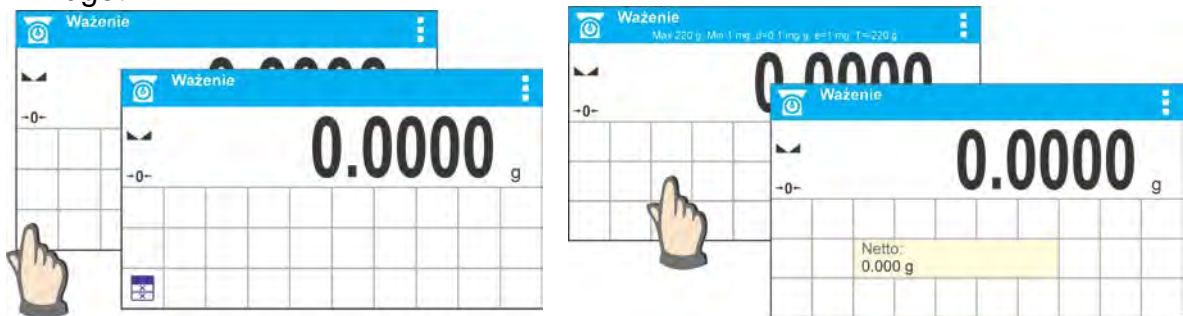

3. A new widget can only take such area that holds no other widgets yet. The program automatically detects suitable widget size matching particular area.

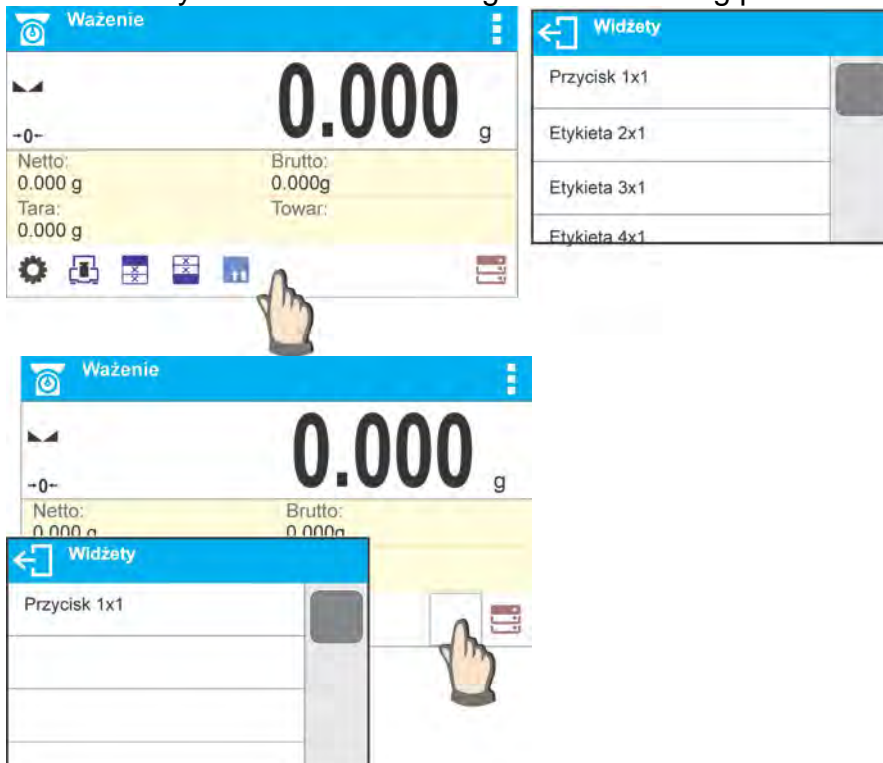

4. It is possible to change functions assigned to an already applied widget. The applied widget, if not needed, can be removed.



- In order to rearrange widgets layout, it is necessary to delete already applied widgets first, and define new arrangement of buttons, labels and text fields next.

8.6.1. Quick Access Buttons

You can define quick access buttons, the buttons are displayed underneath weight indication section. Upon selecting button from the list it is displayed in selected field. These are so called quick access buttons for triggering the most often performed operations.





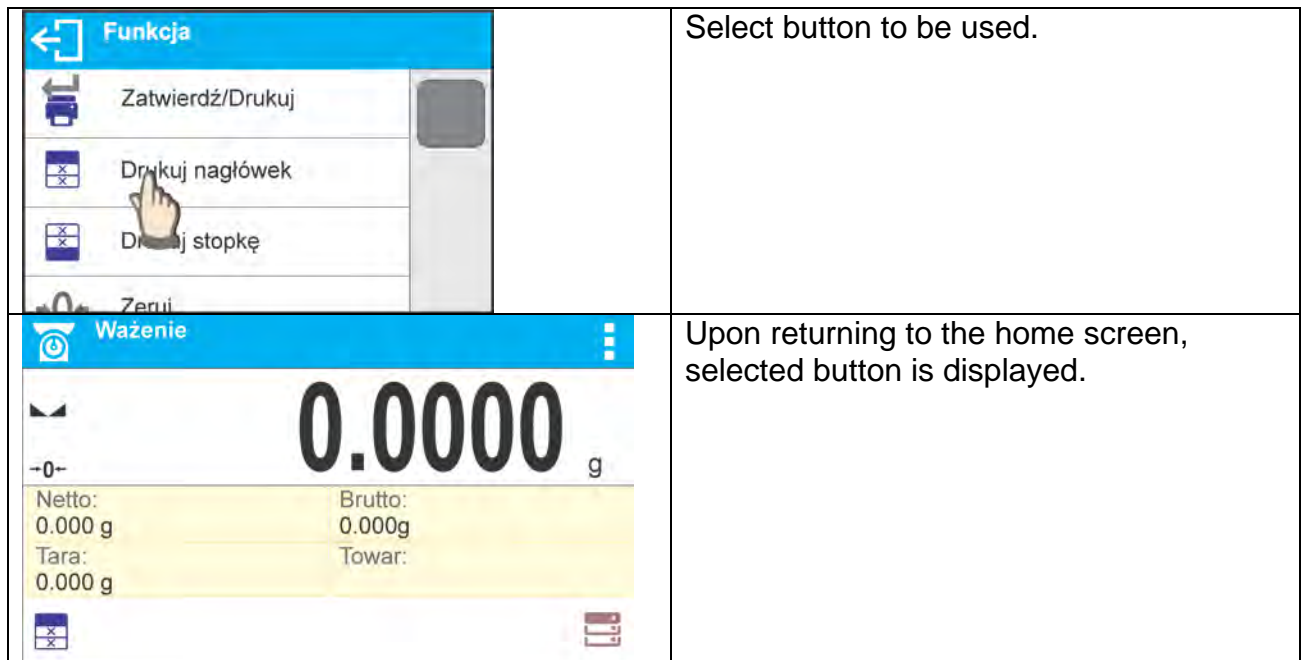







Procedure:

	<p>Press and hold the spot where a given button it to be placed.</p>
	<p>Press: Button 1x1.</p>
	<p>Enter particular button function settings.</p>



Quick access buttons list:



<i>Button</i>	<i>Function</i>	<i>Modes featuring the button</i>
	Accept/Print	All modes
	Print header	Weighing mode exclusively
	Print footer	Weighing mode exclusively
	Zero	All modes
	Tare	All modes
	Set tare	All modes
	Change unit	Weighing mode exclusively
	Select unit	Weighing mode exclusively
	Parameters	All modes
	Databases	All modes
	Operator	All modes
	Product	All modes
	Customer	All modes
	Packaging	All modes
	Adjustment	All modes

	Variable 1	All modes
	Variable 2	All modes
	Variable 3	All modes
	Working mode parameters	All modes
	Hide/show last digit	Weighing mode exclusively
	Drying program	Drying mode exclusively
	Drying profile	Drying mode exclusively
	Finish mode	Drying mode exclusively
	Printout interval and unit	Drying mode exclusively
	Open/close drying chamber	All modes
	Start	Drying mode exclusively
	Profile	All modes

8.6.2. Labels

You can select label size and type of information to be displayed for particular label. Upon label selection, specify type of information to be displayed for the label. The selected label is displayed automatically on a specified home screen spot.

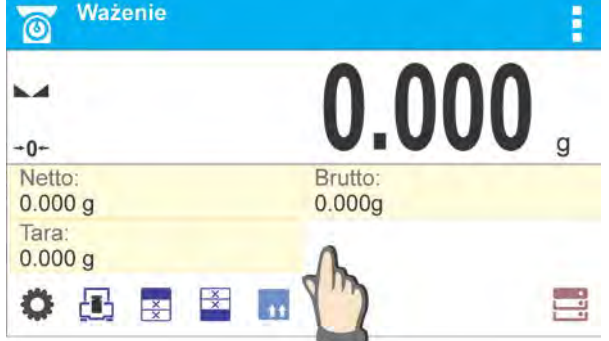
Procedure:

	<p>Press and hold the spot where a given button it to be placed.</p>
	<p>Select a label and its dimensions.</p>

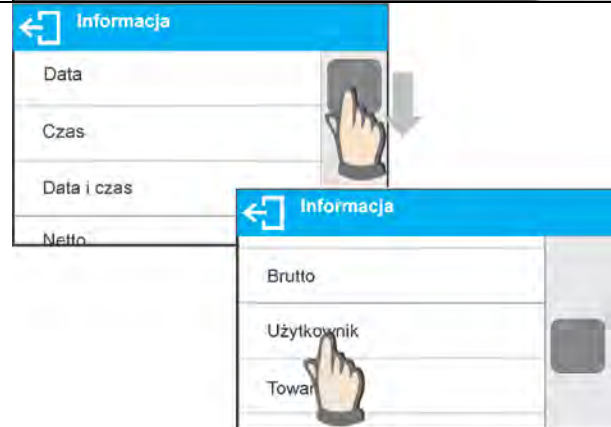
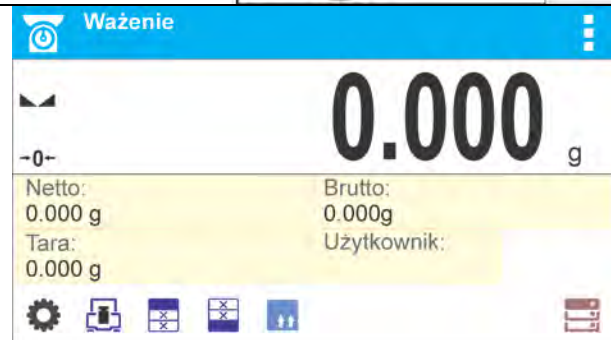
	<p>Label settings window opens, click INFORMATION field in order to see a list of information type available for the selected label.</p>
	<p>Select data to be displayed.</p>
	<p>Upon returning to the home screen, selected label is displayed.</p>

Labels list:

<i>Label information type</i>	<i>Modes featuring the information</i>
Date	All modes
Time	All modes
Date and time	All modes
Net	All modes
Tare	All modes
Gross	All modes
Operator	All modes
Product	All modes
Packaging	All modes
Customer	All modes
Variable 1	All modes
Variable 2	All modes
Variable 3	All modes
MSW value	Weighing mode exclusively
MSW tare	Weighing mode exclusively

MSW status	Weighing mode exclusively
Drying program	Drying mode exclusively
Drying profile	Drying mode exclusively
Finish mode	Drying mode exclusively
Printout parameters	Drying mode exclusively
Drying process status	Drying mode exclusively
Drying chamber status	Drying mode exclusively
Prognosis	Drying mode exclusively
Target value	Drying mode exclusively

The above presented information type has been designed for particular working modes. Detailed description for a given information type is provided within section overviewing a respective mode.





8.6.3. Text Fields

You can select text field size and type of information to be displayed in the first and the second line of the field, plus you can decide on a function that is to be assigned to a particular text field.

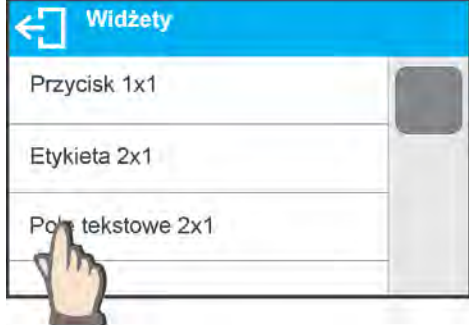
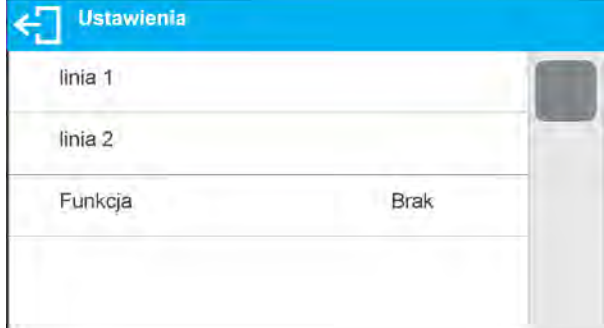
Upon completed setup operation, the selected text field is displayed automatically on a specified home screen spot.

Procedure:

	<p>Press and hold the spot where a given button it to be placed.</p>
	<p>Select a text field and its dimensions.</p>
	<p>Text field settings window opens. Define particular text field parameters:</p>

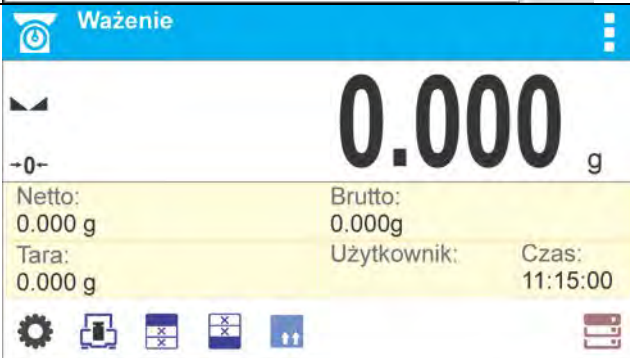
	<p>line 1: e.g. text <Time:>,</p>
	<p>line 2: e.g. variable {3}, variable for current time displaying (other variables refer to section on non-standard printouts defining),</p>
	<p>Function: e.g. adjustment.</p>
	<p>When all text field parameters have been defined, the window displays respective values.</p>
	<p>Upon returning to the home screen, determined text field is displayed.</p>

8.6.4. Bar Graphs

Bar graph is available for all working modes.

It informs you how much of the weighing device capacity is used. <SAMPLE MASS CONTROL> parameter, active in the drying mode, illustrates the location of Min and Max thresholds for a given sample mass.

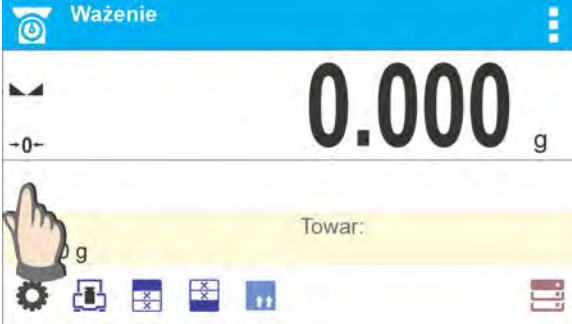
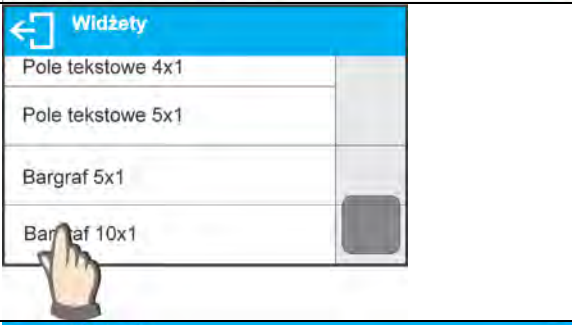
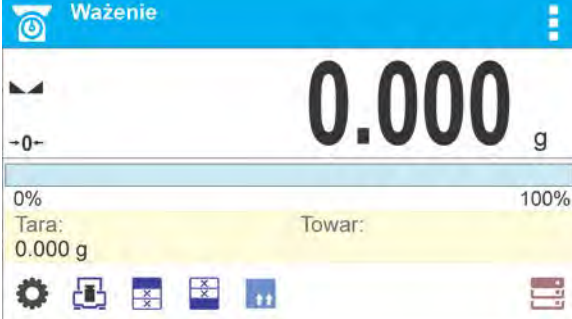

Procedure:

	<p>Press and hold the spot where a bar graph is to be placed.</p>
	<p>Select a bar graph and its dimensions.</p>
	<p>Upon returning to the home screen, selected bar graph is displayed.</p>

9. WEIGHING

Load the weighing pan. Upon displaying  marker on the left, you can read weighing result.

Record/printout of the measurement result is available on pressing <PRINT> key:

- for verified weighing instruments – only stable weighing result is recorded or printed (stability marker  displayed),
- for non-verified weighing instruments – stable or unstable weighing result is recorded or printed (stability marker  not displayed); Unstable weighing result is marked with <?> on the printout, the question mark is printed next to the weight value.

9.1. Good Weighing Practice

To assure long-term operation and correct mass measurements, follow the rules presented below:

- Start the moisture analyzer with no load on the weighing pan (permissible value of load on the weighing pan at start is $\pm 10\%$ of the maximum capacity).
- Load the weighing pan steadily avoiding shocks:

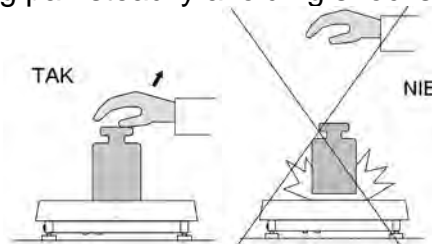

- Place weighed loads centrally on the weighing pan:

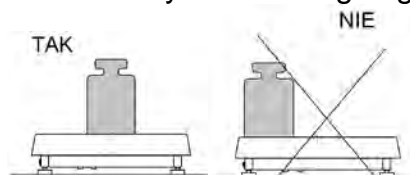

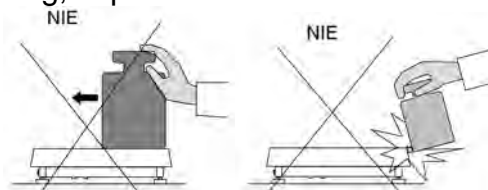

- Avoid side loading, in particular side shocks:



9.2. Log In Operation

In order to access operator-related parameters and in order to edit databases, you need to log in as an operator with **<Administrator>** permissions levels.

First log in operation:

- Go to home screen, press  button, wait for the operators database to open.
- Select **<Admin>** operator, wait for the on-screen keyboard with a password box to open.
- Enter „1111” password and press  button to confirm.
- The home screen is displayed.

- When logged, add operators and set permissions (*for detailed procedures read the user manual*).

While logging in again, select an operator from the list and enter the password; the program initiates operation with permissions set for the selected operator.

Log Out operation:

- Go to home screen, press  button, wait for the operators database to open.
- Select **<Log out>** option (*1st position on the operators list*).
- The home screen is displayed.

Permissions

There are 3 permissions types: *administrator, advanced operator, operator.*



Access to operator-related parameters, databases and program functions is conditioned by permissions:

<i>Permissions</i>	<i>Available parameters and functions</i>
Operator	Operator can edit the following submenus: parameters of <Readout/Filter> submenu, set parameters of <Misc.> submenu (except for <Date and time>, <Permissions>, <Software update> parameters). Operator can run and carry out all weighing operations. Operator can preview <Databases> data, and define universal variables.
Advanced operator	Operator can edit the following submenus: <Readout>; <Working modes>; <Communication>; <Peripherals>; <Misc.> (operation of <Date and time>, <Permissions> and <Databases> edition excluded). Operator can run and carry out all weighing operations.
Administrator	Operator can edit all operator-related parameters and all databases, and use all functions.

9.3. Units

UNITS parameter group enables you to specify which mass units are to be available in the course of operation, and to define two custom units. These two options improve both comfort and speed of work. It is possible to change unit to other than unit [g] in WEIGHING mode exclusively.



9.4. Weighing Unit Selection



In order to change the weighing unit either press the weighing unit pictogram displayed next to the weighing result value or press  button (if provided in the information box). Pressing the unit triggers its change, the clicked unit gets replaced with the unit that is next on the list of available units. Another method for unit change is selecting a particular unit out of the units list, to view the list press  button (if provided in the information box).

Units list:

Unit	Denotation	Unit	Denotation
gram	[g]	Taele Taiwan	[tlt]
milligram	[mg]	Taele China	[tlc]
carat	[ct]	Momme	[mom]
pound	[lb]	Grain	[gr]
ounce	[oz]	Newton	[N]
ounce Troy	[ozt]	Tical	[ti]
pennyweight	[dwt]	baht	[baht]
Taele Hongkong	[tlh]	tola	[tola]
Taele Singapore	[tls]	mesghal	[msg]

9.5. Weighing Units Availability

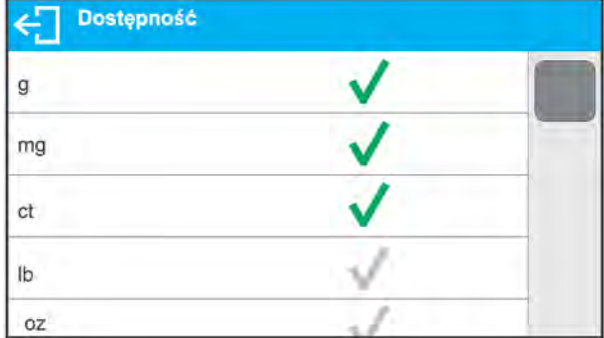
You can declare which units are to be accessible upon pressing  button. Units with parameter value set to <Yes > option are available for selection in particular working modes, i.e. modes facilitating units change.

	<p>Units with parameter value set to <No > option will not be accessible in the course of the weighing instrument operation.</p>
--	--

9.6. Start Unit Selection

Upon setting start unit, the moisture analyzer activates with the set start unit for these modes where change of the unit is possible.

Accessibility of particular units is conditioned by the weighing instrument status; i.e. it depends on the fact whether the given weighing instrument is verified or not.

	
---	--

9.7. Custom Units

Parameter allowing you to declare two custom units. Displayed custom unit value is a result of calculation, where obtained in the course of measurement weight value is multiplied by a multiplier determined for this particular custom unit. The custom units can be freely named with use of 3 characters maximum. By default the custom units are marked as: **[u1]** – custom unit 1 and **[u2]** – custom unit 2.



9.8. Zeroing

To zero mass indication press $\rightarrow 0 \leftarrow$ key. Zero indication and the following pictograms are displayed: $-0-$ and $\blacktriangle\blacktriangle$.

Zeroing operation means determining new zero point, recognized by the weighing device as precise zero. The instrument can be zeroed only when the indication is stable.

Caution:

Indication can be zeroed only within $\pm 2\%$ range of maximum capacity. If the zeroed value is above $\pm 2\%$ of the maximum capacity, then the software displays a respective error message.

9.9. Taring



To determine net weight value, load the weighing pan with a packaging, wait for a stable indication and press $\rightarrow T \leftarrow$ key. Zero indication and the following pictograms are displayed: **Net** and $\blacktriangle\blacktriangle$. Upon unloading of the weighing pan, the sum of tared masses with minus sign is displayed. You can assign tare value to a particular product stored in the database. In such case the assigned tare value is automatically acquired upon selection of the given product.

Caution:

It is impossible to tare negative values. When you try to tare negative values, the weighing instrument responds with an error message. In such a case, zero the indication and repeat taring procedure.

Press to enter tare manually.

Procedure:

- Press quick access button - . The key is available regardless of the working mode you operate.
- An on-screen numeric keyboard is displayed.
- Enter tare value and press  button.
- Moisture analyzer returns to weighing mode. Tare value with „-“ sign is displayed.

Deleting Tare

The tare value indicated on the display can be deleted by pressing  key on the operation panel, or by using programmable <Deactivate tare> function button.

Procedure 1 - upon taking the tared load off the weighing pan:



- Press  key,
- The <Net> marker gets deleted, new zero point is determined.

Procedure 2 - with tared load on the weighing pan:

- Press  key,
- The <Net> marker gets deleted, new zero point is determined.
- When the zeroed value is above 2% of the maximum capacity, then the software displays a respective error message.

Selecting tare value out of PACKAGING DATABASE

Procedure:

- Press  key located on the operation panel.
- Wait for a respective window to open, next press  button (PACKAGING).
- Window with a list of tare values recorded into packaging database opens.
- Select the packaging that is to be used.
- Moisture analyzer returns to weighing mode. Tare value with „-“ sign is displayed.

OR

- Press  button (if provided on the display).
- Window with a list of tare values recorded into packaging database opens.
- Select the packaging that is to be used.
- Moisture analyzer returns to weighing mode. Tare value with „-“ sign is displayed.

Autotare

Autotare function provides automatic taring of the packaging during the weighing process when packaging mass for each of the product is different. For detailed description of Autotare function operation, read later section of this user manual.

Deleting Tare

The entered tare value can be deleted by pressing  key, located on the operation panel, or by entering value of 0.000g (read the above description).

9.10. Weighing Profile

In order to make operation with the balance easier, 4 various profiles have been designed. Parameters for these profiles have been set (and saved) in a way ensuring that the weighings are carried out optimally for particular requirements and conditions.

Profile parameters concern settings of a given working mode, they are grouped in parameter: *Setup/Working modes/Weighing/Readout*.

For detailed description of Profile settings read the next section of this user manual.

Profile types:

- **User** – basic profile, filters settings provide quite fast and precise measurement.
- **Fast** – profile set to enable fast measurement of mass of any size regardless of the selected working mode. Fast profile gets activated automatically at the first moisture analyzer start-up. For Fast profile, the parameters settings enable obtaining the final result as fast as possible.
- **Fast dosing** – profile intended for dosing, it is set to enable fast dispensing of product.
- **Precision** – profile set to enable precise measurement of mass of any size regardless of the selected working mode. For Precision profile the weighing process takes a lot of time, but this guarantees the most precise weighing result.

Caution: as an operator you can modify all profile settings only for User profile, when it comes to the remaining default profiles (Fast, Fast dosing and Precision) they can only be modified partially.

At the top of the screen a respective pictogram (a letter) is displayed, it informs which profile is currently operated. The profile can be selected separately for a given working mode. The most recently used profile is remembered for each working mode (along with all introduced modifications), the mode, when activated, is run with the most recently used profile.



Profiles pictograms:

No.	Pictogram	Description
1	U	User profile
2	F	Fast profile
3	D	Fast dosing profile
4	P	Precision profile

Profile selection procedure:

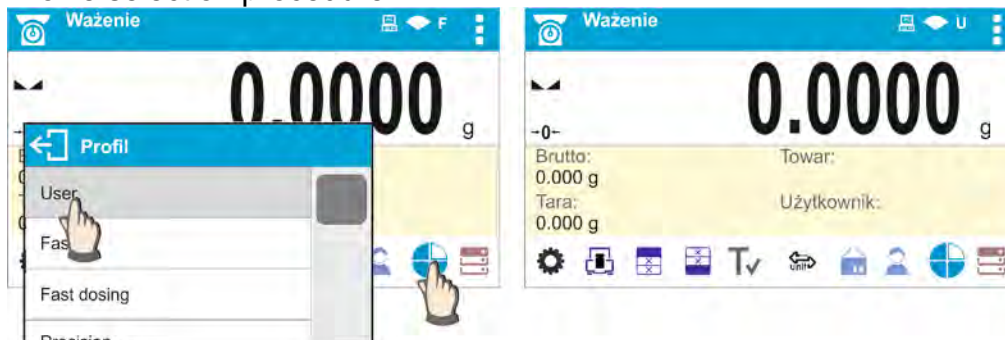

9.11. <WEIGHING> - Readout Mode Settings

The software allows setup of operating parameters (filters, value release and autozero function, deleting the last digit and other settings) separately for each working mode. As an operator you can modify all profile settings only for **User** profile, when it comes to the remaining default profiles (**Fast, Fast dosing, Precision**) they can only be modified partially, i.e. you are not allowed to change **Filter and Value release** parameters for these profiles, the said parameters are set to default factory values.

It enables customizing the instrument and utilizing its properties depending on your needs and expectations, or on specific requirements for selected working mode (e.g. DRYING); as a result the device operation is quick and easy.

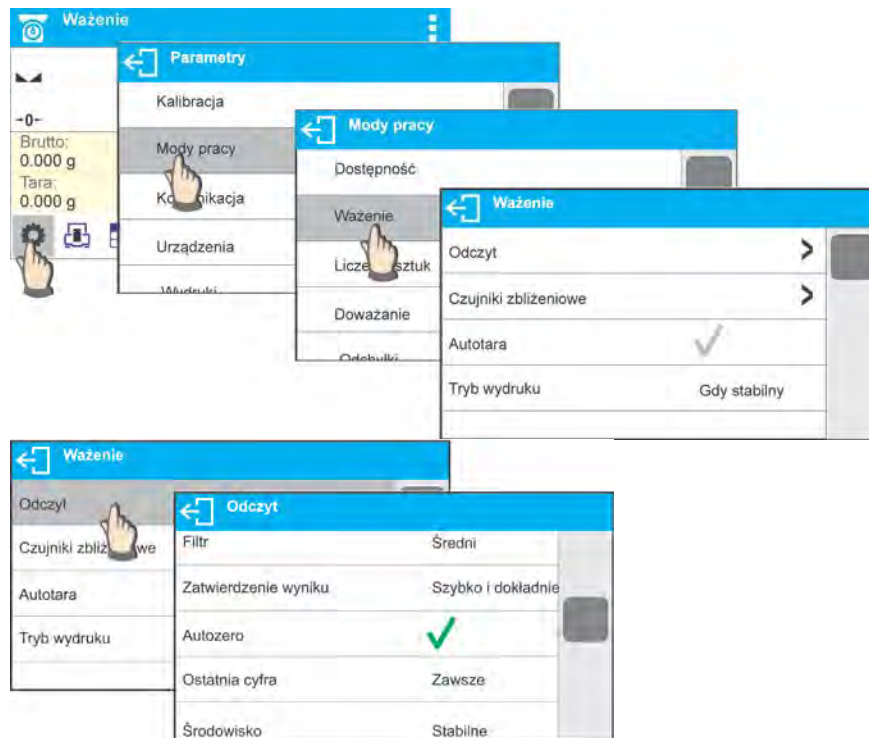

Setting filter level (option disabled for the following profiles: Fast, Fast dosing, Precision)

Filter settings depend on the working environment. For the best possible conditions the filter can work in a very fast mode (V.FAST value for Filter parameter); however, if the conditions are poor (shakes, drafts), the filter should be set to slow or very slow option (SLOW or V. SLOW value for Filter parameter). The effectiveness of the filter is different throughout the weighing range. The filter works slower when the weight value of weighed mass is about to be determined, it works more intensively when the weighed mass is within the set range of the filter (parameter for setting filter range is accessible only from the service menu – the user does not have any access to it).

Depending on the filter, the weighing time is shorter (V.FAST and FAST) or longer (SLOW and V. SLOW).



Caution:

The higher filter level, the longer the weighing takes.

Value release (option disabled for the following profiles: Fast, Fast dosing, Precision)

Since ambient conditions at a workplace vary, it is necessary to determine the value release parameter in the most preferable way enabling weighing instrument adaptation, parameter options are: **FAST, FAST + RELIABLE** or **RELIABLE**. Depending on the selected option,

weighing time is either shorter or longer.

Autozero function

The software offers an autozero function (**Auto**) ensuring precise mass indication. The function has been designed to enable automatic control and correction of zero indication. If the function is enabled, the following measurement results are compared to each other at declared time intervals, e.g. every second. The said comparison takes place when the weighing pan is unloaded and the displayed indication is close to zero. If the difference between the results is lower than declared AUTOZERO range value, e.g. 1 division, the indication gets zeroed automatically, and the markers of stable indication – **▲▲** and precise zero – **-0-** are displayed. Active Autozero function means, that each measurement starts with the precise zero. There are, however, some cases when this function can be a disturbing factor for the measuring process, e.g. very slow placing of a load on the weighing pan (load adding, e.g. pouring, filling). In such case, the system correcting zero indication may also correct the indication of actual weight of load placed on the weighing pan.

Last digit display

Function enabling/disabling display of the last digit (placed on the right of the decimal point) of the weighing result. Accessible settings:

- **Always:** all digits are displayed.
- **Never:** last digit disabled.
- **When stable:** last digit displayed only when the result is stable.

Moisture analyzer ambient conditions

Parameter relating to ambient and environmental conditions of the workstation.

Available values: <STABLE> and <UNSTABLE>. Setting STABLE value makes the weighing instrument work much faster; i.e. weighing takes much less time than in case of setting the parameter to UNSTABLE value. Enter <AMBIENT CONDITIONS> parameter and set <UNSTABLE> value if the ambient conditions are unfavourable (air drafts, vibrations). By default the parameter is set to value: <STABLE>.

9.12. Proximity Sensors

The weighing device is equipped with two proximity sensors which enable touch free control.

The program detects two motions performed around the sensors:

1. Hand in a close vicinity to the left sensor **<Left sensor>**.
2. Hand in a close vicinity to the right sensor **<Right sensor>**.

Each motion can trigger optional weighing device function. For available functions list read section 8.6.1. Upon completed configuration procedure, the software runs function assigned to a particular proximity sensor, having detected motion around it. To provide correct operation, it is necessary to set respective proximity sensors sensitivity (*read section 10*).

9.13. Autotare

Autotare function allows you to quickly determine net weight for loads with different tare values, which loads are measured one after another.

When autotare is enabled (<AUTOTARE> parameter set to <YES> value), operation takes the following order:

- Make sure that the weighing pan is empty and press zeroing key.
- Load the weighing pan with product packaging (packaging weight value must be greater than the set value of AUTO THRESHOLD parameter).

- Upon indication stabilization, packaging mass is **automatically tared** (**Net** pictogram is displayed in the upper part of the display).
- Put/pour/dispense product that is to be packed into the packaging.
- Net mass is displayed.
- Unload the weighing pan (remove both product and packaging).
- When the weighing device detects weight value lower than gross weight value set in **<AUTO THRESHOLD>** parameter, the entered tare value gets automatically deleted (**Net** pictogram is no longer displayed).
- Load the weighing pan with packaging of another product, upon indication stabilization, packaging mass is automatically tared (**Net** pictogram is displayed in the upper part of the display).
- Put/pour/dispense product that is to be packed into the packaging.

For correct operation of the weighing instrument with AUTOTARE function, it is necessary to adjust the threshold value.

<AUTO THRESHOLD> parameter refers to the following functions:



- autotare,
- automatic printout.

No automatic taring takes place as long as the gross weight value stays within the range set in **<AUTO THRESHOLD>** parameter.

9.14. Print Mode

Function designed to enable print mode setting, i.e.  key activation.

Available values:

- **<WHEN STABLE>** - for this value stable measurement result, along with the settings for **<GLP PRINTOUT>** parameter, is sent to the printer port. Upon pressing  key at the moment when the result is unstable (no  pictogram displayed), the program first waits for the stability condition to be met, next sends the measurement result to the port.
- **<EACH>** - every single pressing of  key results with sending the measurement indication to the printer port along with the settings for **<GLP PRINTOUT>** parameter. Every single indication is sent (stable and unstable). In case of unstable indication, **<?>** sign is displayed in front of the weighing result frame.
Function available for non-verified moisture analyzers exclusively.
- **<AUTO>** - select this value to enable automatic printout. When selecting **<AUTO>** value remember to set **<AUTOPRINT THRESHOLD>** in accordance with your requirements.
- **<AUTO + INTERVAL>** - select this value to start automatic print and record of indications in WEIGHINGS and ALIBI databases, carried out in a cyclic manner in a specified time intervals. The interval is set in [min] in **<INTERVAL>** parameter. Interval range is 1 - 9999 min.

Caution:

Each weighing result is printed and recorded (stable and unstable for a non-verified moisture analyzer, stable for a verified moisture analyzer).

Automatic operation with interval starts at the moment of switching the function on. The first stable weighing result of value greater than AUTO THRESHOLD value is printed and recorded as the first measurement. The following measurements are printed with frequency set in INTERVAL parameter. To stop the automatic operation with interval, switch the option off.

Upon switching the function of auto print with interval on, PRINT button becomes inoperative (no indication is printed when pressed).

Automatic operation procedure:

- Press →0← key to zero the indication (stability marker ▲▲, and zero pictogram -0- are displayed).
- Load the weighing pan, the first stable measurement is sent to the printer port.
- Unload the weighing pan.
- The next measurement is possible when the indication gets lower than the value set for <AUTO THRESHOLD> parameter (next measurement does not require zero value).

For automatic operation it is necessary to adjust the threshold value. The measurement is sent to a computer or a printer when mass indication gets below the set net value of <AUTO THRESHOLD> parameter.

<AUTO THRESHOLD> parameter refers to the following functions: automatic tare, automatic operation, autoprint with interval.

9.15. Minimum Sample Weight

Weighing mode comprises <Minimum sample weight> function. In order to use this function it is necessary to enter minimum sample weight (MSW) value and tare values for which the MSW value is to be obligatory. For standard MAX2 series the values are zero.

Only authorized RADWAG employee or operator with Administrator permissions, providing that moisture analyzer factory settings enable this, can carry out procedure aiming to determine minimum sample weight and next enter the respective data.

Should you use the minimum sample weight function, and need data on minimum sample weight to be entered to moisture analyzer menu, please contact the local representative of "RADWAG" company.

Using reference sample weights, the authorized RADWAG employee determines minimum sample weight for specified tare containers. This operation is carried out at the place of use and in accordance with requirements of the applied quality system. The obtained value is entered into the weighing instrument program.

The weighing instrument program enables defining tare value with assigned minimum sample weight value.

<Minimum sample weight> function guarantees that the results of weighing operation are comprised within the set tolerance, in accordance with applied quality management system of particular company.

Caution: Function valid for weighing mode exclusively.

Available options:

- **MODE**
 - None** – minimum sample weight function off.
 - Block** – select to enable display of respective pictograms informing you about the measured mass (whether it is lower than the MSW value or higher than the MSW value); with this option on, the program makes it impossible to accept the measurement that is lower than the MSW value.
 - Warn** – select to enable display of respective pictograms informing you about the measured mass (whether it is lower than the MSW value or higher than the MSW value). You can accept the measurement that is lower than the MSW value.
- **Tare** – maximum tare value, for which the minimum sample weight is obligatory (analyse the below examples).

- **Minimum mass** – value of the minimum sample weight determined for a particular weighing device on site with use of respective method.

Example no. 1 for moisture analyzer with d=0.0001 g:

No.	Tare value	Minimum sample weight	Overview
2	10.0000 g	1.0000 g	Minimum sample weight refers to all net weight values when weighing is carried out using a tare container of mass ranging from 0.0001 g to 9.9999 g inclusive (<TARE> button used). In case of such settings, the minimum sample weight is valid only when you weigh samples in a tare container of weight value comprised within the above specified range. If taring function IS NOT used, or if the tare container's weight ranges between 10.0000 g - Max, then pictogram informing on use of minimum sample weight goes blank.

Example no. 2 for moisture analyzer with d=0.0001 g:

No.	Tare value	Minimum sample weight	Overview
1	220.0000 g	0.5000 g	Minimum sample weight refers to all net weight values when weighing is carried out using a tare container of mass value comprised within the whole weighing range (<TARE> button used). In case of such settings, the minimum sample weight is valid only when you weigh samples in a tare container. If taring function IS NOT used then pictogram informing on use of minimum sample weight goes blank.

Example no. 3 for moisture analyzer with d=0.0001 g:

No.	Tare value	Minimum sample weight	Overview
1	0.0000 g	0.2500 g	Minimum sample weight refers to all net weight values when weighing is carried out without use of a tare container (<TARE> button NOT used). In case of such settings, the minimum sample weight is valid only when you weigh samples without use of tare containers. If taring function IS used then pictogram informing on use of minimum sample weight goes blank.

You can preview the entered data, but you are not allowed to edit it.

Weighing with use of MINIMUM SAMPLE WEIGHT function

If in the course of weighing you want to find out whether a particular measurement value is higher than the MSW value, specified for a given weighing range, then <Minimum sample weight> function must be on. To turn the function on go to weighing mode settings.

Procedure (Administrator exclusively):

1. Enter weighing mode settings.
2. Enter <Minimum sample weight> parameter group.
3. Press <Mode> parameter.
4. Settings box is displayed, select respective option:
 - Block** – select to enable display of respective pictograms informing you about the measured mass (whether it is lower than the MSW value or higher than the MSW

value); with this option on, the program makes it impossible to accept the measurement that is lower than the MSW value.

Warn – select to enable display of respective pictograms informing you about the measured mass (whether it is lower than the MSW value or higher than the MSW value). You can accept the measurement that is lower than the MSW value.

5. Go to the home screen.
6. Section presenting the weighing result comprises additional pictogram providing supplementary information. The pictogram changes in the course of weighing operation, it informs you on the weighed sample mass; the information is referred to the declared minimum sample weight value.

<p>Weight value lower than the MSW value specified for a particular tare range.</p>	<p>Weight value higher than the MSW value specified for a particular tare range.</p>

Pictograms providing MSW-related information:

	<p>Weight value lower than the specified MSW value.</p>
	<p>Weight value higher than or equal to the specified MSW value.</p>

Caution:

If more than one reference tare value is programmed (with corresponding minimum sample weight mass) then the indicated value automatically moves to a range corresponding to the weight of the tared container. At the same time the required minimum mass is changed.

9.16. Integration with Titrators

In order to provide correct integration with TITRATORS, go to settings of standard printout content and set <Mass value for a titrator> parameter to <Yes> value. With this, other variables for the printout are turned off.

<p>The pictogram informs on special format of mass printout, permissible by TITRATORS.</p>	

10. MISCELLANEOUS PARAMETERS

Parameters facilitating moisture analyzer operation. To set these parameters go to **<MISC.>** submenu.

For detailed instruction on how to set up particular parameters read section 8 of this user manual.

Menu Language

Language parameter enables selecting the language of the moisture analyzer menu descriptions for unlogged operator.

Available languages: POLISH, ENGLISH, RUSSIAN, UKRAINIAN, HUNGARIAN, SPANISH, FRENCH, GERMAN, ITALIAN, CZECH, CHINESE, ARABIC, TURKISH, KOREAN.

In order to change menu default language for unlogged operator select new language (**Setup/Misc./Language**) and restart the moisture analyzer.

Permissions

Parameter allowing you to set permissions for unlogged operator.

Available permissions: ADMINISTRATOR; ADVANCED OPERATOR; OPERATOR

Depending on selected permissions level, you can enter moisture analyzer parameters and modify settings, as far as possible for a particular level. Logging in is not required (*for permissions overview read section 9 of this user manual*).

'Beep' Sound

Parameter allowing you to enable/disable sound signal informing the operator about pressing button(s) or key(s) or about operation of proximity sensors.

Setting:

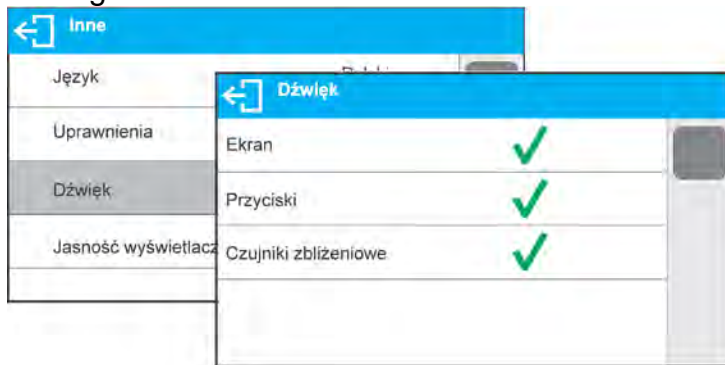

Display Brightness

The parameter enables setting display brightness. The backlight can be disabled completely.

Setting:

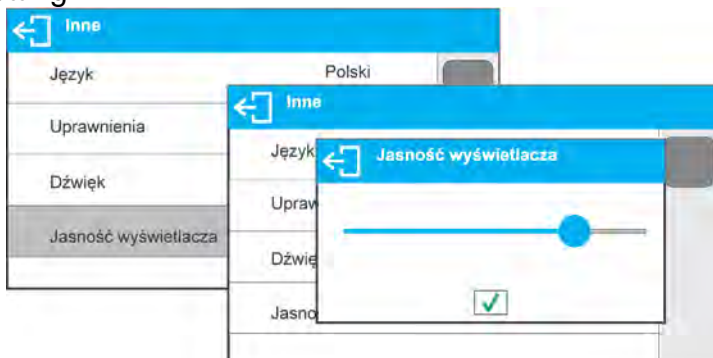

Proximity Sensors Sensitivity

The parameter is adjustable between 0 – 100, and it determines the distance from which the IR proximity sensors react. The distance can be adjusted within 0% - 100% range, for lower values the proximity sensors operate at a shorter distance.

Setting:

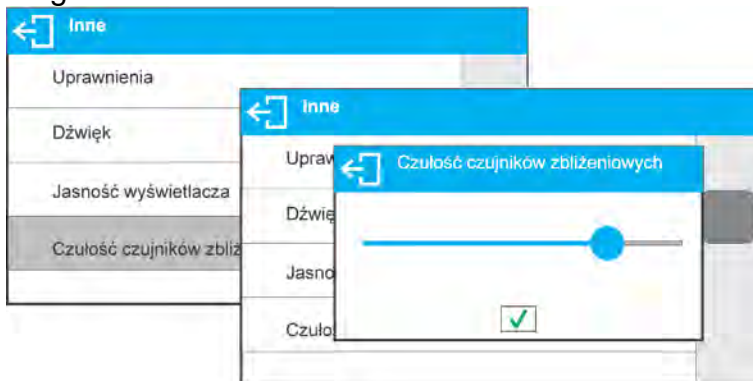

Date

Enter this parameter to set current date.

Setting:



Time

Enter this parameter to set current time. Time and date parameters modification proceeds likewise.

Date Format

Enter this parameter to set date format [YYYY.MM.DD / YYYY.DD.MM / DD.MM.YYYY / MM.DD.YYYY]; where: YYYY – year; MM – month; DD – day.

Time Format

Enter this parameter to set time format [12h/24h].

When you set [12h] value for **TIME** parameter, <A> or <P> letter is displayed next to the time. **A** stands for hours before the noon, **P** stands for hours after the noon. Time printout features either letters **AM** or **PM**.

Backlight Standby Time

Parameter allowing you to set time interval, in [min], after which the screen goes black when no weighings are being carried out. The screen will go black if the weighing result is stable.

NONE - backlight standby time inactive, **0.5; 1; 2; 3; 5** - time given in minutes.

If the indication is stable during the declared time interval, the backlight gets deactivated automatically. Backlight activates upon indication change (stability marker not displayed) or upon pressing operation panel key. Backlight deactivation works also when the weighing instrument's menu is entered.

Automatic Shutdown

Parameter allowing you to set time interval, in [min], after which the weighing device shuts down automatically (this function is similar to function of  key). Upon switching the display off, the other subassemblies remain powered and the weighing instrument is ready for operation.

NONE - automatic shutdown inactive, **1; 2; 3; 5; 10** - time given in minutes. If the indication is stable during the declared time interval, the screen is shut down automatically.

In order to switch the weighing instrument on, press  key of the operation panel. Weighing process gets started automatically. Shutdown function is inactive and the device cannot be turned off if any process is started or if you operate the menu.

11. ADJUSTMENT

In order to ensure the highest weighing accuracy, it is recommended to periodically introduce a corrective factor of indications to moisture analyzer memory, the said factor must be referred to a reference mass.

Adjustment has to be carried out:

- prior weighing,
- if long breaks between successive measuring series occur,
- if the weighing instrument temperature has changed by 2°C

Adjustment types:

- adjustment performed using an external weight of declared mass, which mass cannot be modified, or using an external weight of mass equal to or greater than 30% of the maximum capacity.



Caution:

*Remember to carry out the adjustment process when there is no load on the pan! When the weighing pan is loaded, command **<RANGE EXCEEDED>** is displayed. In such case, unload the weighing pan and repeat the adjustment. Adjustment process can be aborted if necessary, to do it press  key.*

11.1. Internal Adjustment

Caution: function enabled for MA xx.X2.IC.A moisture analyzers exclusively.

Internal adjustment is carried out by means of an internal adjustment weight.  button, when pressed, automatically triggers adjustment process. Upon adjustment process completion, a respective message is displayed informing on the process status.



Caution:

Moisture analyzer adjustment procedure requires stable conditions (no air drafts, no vibrations), the weighing pan must be unloaded in the course of adjustment.

11.2. External Adjustment

External adjustment is carried out using an external mass standard of the right accuracy and weight value, which value depends on weighing device model and capacity. Correction is carried out semi-automatically, successive process stages are signalled with prompts.

Procedure:

- Enter <Adjustment> submenu, next select “External adjustment” option.
- Message <Remove weight> is displayed.
- Unload the weighing pan and press  button. The balance determines start mass, message: **<Adjustment; Please wait...>** is displayed.
- Upon completed start mass determination, message <Put weight> is displayed along with particular value of mass standard assigned to the moisture analyzer.
- Load the weighing pan with the required adjustment weight and press  button.
- Upon completed procedure, message <Remove weight> is displayed.
- Take the weight off the weighing pan, the moisture analyzer displays the <Adjustment> submenu.

11.3. User Adjustment

User adjustment can be carried out using any adjustment weight mass of which ranges 0.3 Max and Max. Operator's adjustment and external adjustment procedures are likewise with one exception, before operator's adjustment start, an edit box for entering mass of the used adjustment weight is opened.

In order to start operator's adjustment, enter <Adjustment> submenu and select <User adjustment> option. Then follow the commands displayed on a screen.

11.4. Adjustment Test

Caution: function enabled for MA xx.X2.IC.A moisture analyzers exclusively.

<Adjustment test> function enables comparing the result of an internal automatic adjustment with the value recorded in mass comparator factory parameters. The comparison is used for determining moisture analyzer sensitivity drift over time.

11.5. Automatic Adjustment

Caution: function enabled for MA xx.X2.IC.A moisture analyzers exclusively.

Enter this menu to specify conditions initiating an automatic adjustment. Options:

- None – automatic adjustment inactive.
- Time – adjustment takes place in time intervals declared in menu <Automatic adjustment time> (10.6).
- Temperature – adjustment is triggered by temperature change.
- Both – adjustment is triggered by both, temperature changes and time.

11.6. Automatic Adjustment Time

Caution: function enabled for MA xx.X2.IC.A moisture analyzers exclusively.

<Automatic adjustment time> parameter determines time interval between successive automatic internal adjustments. The time interval is declared in hours and ranges between 0.5 and 12 hours.

To set time interval for automatic adjustment:

- select <Automatic adjustment time> option,
- using displayed menu, select appropriate time interval (given in hours) which is to elapse between the most recent adjustment and activation of the following automatic internal adjustment.

11.7. Report Printout

Adjustment report is automatically generated at the end of each adjustment process or adjustment test, next it is sent to port selected for <PERIPHERALS/PRINTER> (COM 1 port by default). To declare report content go to <PRINTOUTS/ADJUSTMENT REPORT> submenu.

For instruction on how to declare adjustment report settings read section 'Printouts'.

The report can be printed using printer connected to the moisture analyzer or sent to a computer and saved as a file for the archiving purposes.

11.8. Adjustment of the Drying Chamber Temperature

Additional equipment is required for temperature adjustment.

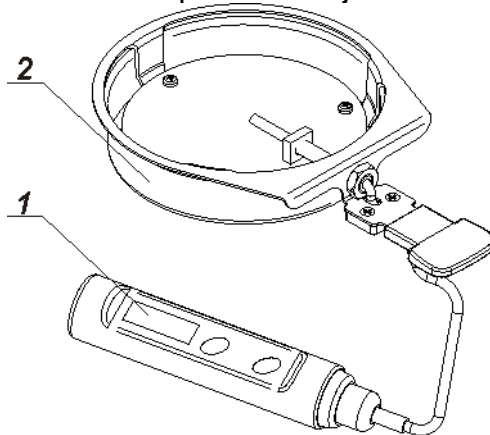

1. Thermometer.
2. Thermometer holder with shield.

Adjustment process is carried out to adjust the temperature of drying chamber sensor. In order to carry out adjustment of moisture analyzer temperature, place the control thermometer as it is presented below:

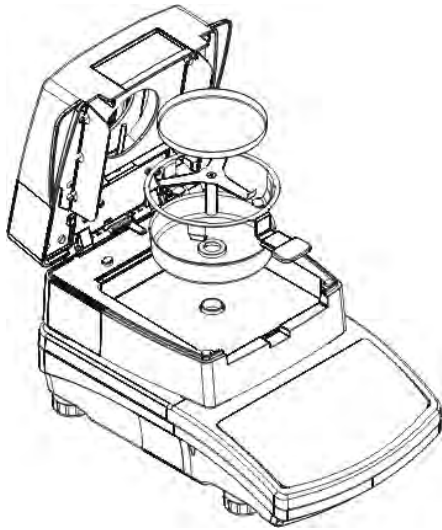

Step 1.

Take the following elements out of the drying chamber:

- disposable pan,
- weighing pan handle,
- cross-shaped holder,
- weighing pan shield.

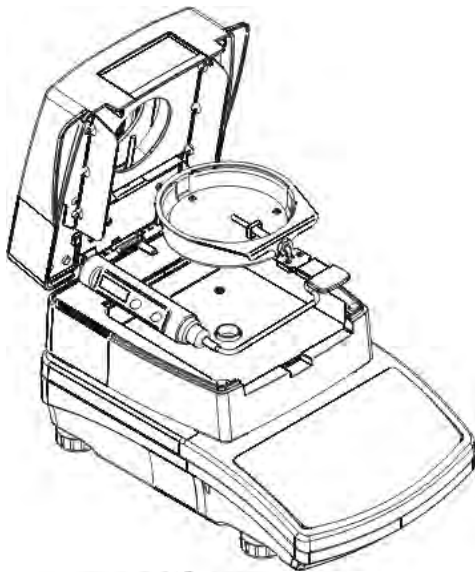

Step 2.

Place the set elements in a drying chamber:

- set shield
set holder together with the thermometer

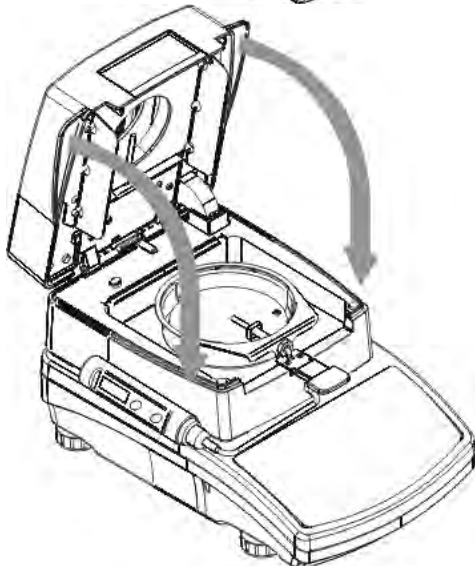

Step 3.

Upon assembling, close the drying chamber and carry out temperature adjustment.

Caution:

Be careful so as not to cause any damages to the moisture analyzer mechanism.

Enter **<Adjustment>** menu and press **<Temperature sensor adjustment>**. Message **<Continue?>** is displayed. Upon confirmation, adjustment of drying chamber temperature sensor starts. Follow the displayed prompts.

The process is carried out in a way presented below. After 8 minutes a numeric keyboard is displayed. Enter the moisture analyzer temperature that is displayed on the control thermometer.



Press ✓ button to confirm, the second step of adjustment starts. The moisture analyzer halogen lamp starts to operate and the drying chamber is heated as long as necessary to provide specified temperature, which is next maintained for 8 minutes. After 8 minutes a numeric keyboard is displayed. Enter the moisture analyzer temperature that is displayed on the control thermometer.



Press ✓ button to confirm, the third step of adjustment starts. The moisture analyzer halogen lamp starts to operate and the drying chamber is heated as long as necessary to provide specified temperature, which is next maintained for 8 minutes. After 8 minutes a numeric keyboard is displayed. Enter the moisture analyzer temperature that is displayed on the control thermometer.



Press ✓ button to confirm. Temperature adjustment process is completed and moisture analyzer displays <Adjustment> window.

For moisture analyzers with maximum heating temperature of 250°C, the temperature adjustment process is likewise, only the temperature values are higher for each part of the process.

11.9. Temperature Test

The parameter allows to check the correctness of indications of moisture analyzer temperature.

In order to test the drying chamber and the drying process you need to use a special adjustment set (thermometer and thermometer holder). The set is an optional accessory of a moisture analyzer (the same that is used for temperature adjustment of the drying chamber). Upon assembling and prior testing, the drying chamber has to be closed. For information on how to assemble the set go to *Drying Chamber Temperature Sensor Adjustment* section.

Enter **ADJUSTMENT** menu and start **<Temperature test>** procedure. Set test parameters in accordance with instruction below and the displayed prompts.

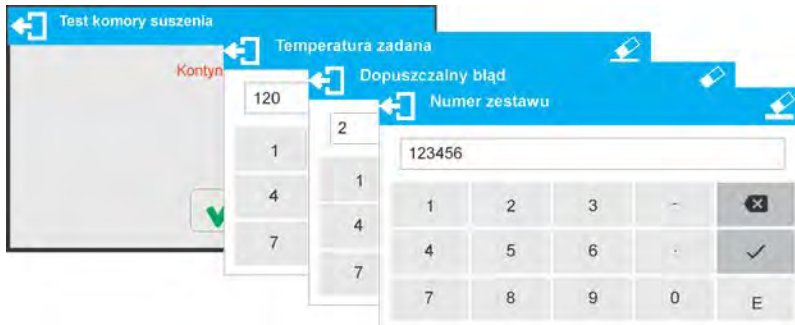

Enter testing temperature, maximum permissible error and the serial number of the temperature adjustment set.

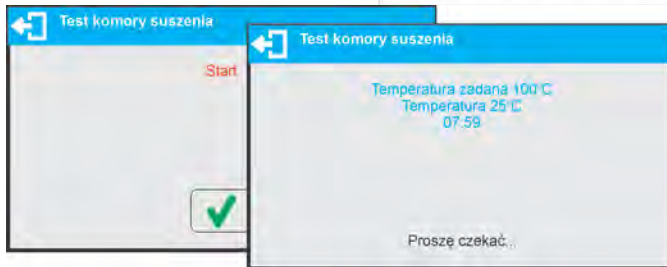

Upon confirmation of serial number **START** message is displayed. Press **✓** button to confirm. The drying process starts and continues until specified temperature is reached. Time and sensor temperature information is displayed.



The temperature is maintained for 8 minutes (like for temperature adjustment procedure). After 8 minutes you shall see a window for entering temperature read from the installed adjustment set. Press **✓** button to confirm.

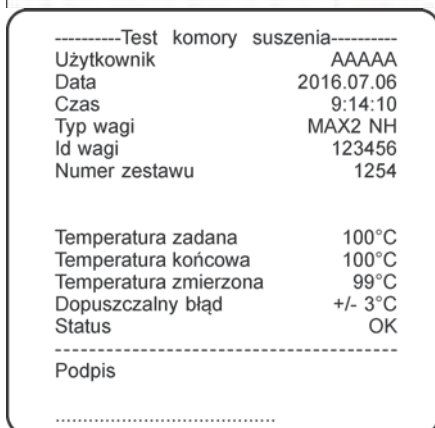

The result of the test may be printed on a printer connected to the moisture analyzer. Look left to see an example of a report.

12. PRINTOUTS CONTENT

12.1. Adjustment Report

ADJUSTMENT REPORT is a group of parameters allowing you to declare data that is to be printed on an adjustment report.

Variable	Description
PROJECT	Project name matching particular weighing type (31 characters maximum).
ADJ. TYPE	Performed adjustment type.
OPERATOR	Logged-in operator name.
PROJECT	Project name printout (see: Project parameter).
DATE	Adjustment performance date.
TIME	Adjustment performance time.
BALANCE S/N	Balance serial number.
ADJUSTMENT RESULT DIFFERENCE	Difference between mass of adjustment weight that was measured during last adjustment and mass of currently measured adjustment weight.
DASHES	Line separating data and signature fields on a printout.
SIGNATURE	An area for the signature of an operator carrying out the adjustment.

• **The way of inserting project name.**

For the parameters described above, one of these values must be selected:

NO - do not print.

YES - print.

Report example:

```



-----Raport kalibracji-----
Rodzaj kalibracji      Zewnetrzna
Uzytkownik            AAAAAA
Projekt               1234/qwas
Data                  2016.07.06
Czas                  10:02:00
Id wagi                123456
Roznica kalibracji    0.001 g
-----
Podpis
-----

```

12.2. Drying Process Report Printout

Group of parameters allowing you to declare variables that are to be printed on a drying report printout. The Drying Process Report is divided into three individually customized sections: header, measurement and footer.

The settings are valid for Drying Process mode exclusively.

HEADER	Group of parameters allowing you to declare variables that are to be printed on a header printout.	
MEASUREMENT	Group of parameters allowing you to declare variables that are to be printed on a measurement printout.	
FOOTER	Group of parameters allowing you to declare variables that are to be printed on a footer printout.	

Variables List



<i>Variable</i>	<i>Description</i>	<i>Active for</i>
START DATE	Option enables printing out the start date of the drying process.	Header
START TIME	Option enables printing out the start time of the drying process.	Header
BALANCE TYPE	Option enables printing out the balance type.	Header
BALANCE S/N	Option enables printing out the balance serial number.	Header
OPERATOR	Option enables printing out the logged in operator name.	Header
PRODUCT	Option enables printing out the name of currently selected product.	Header
DRYING PROGRAM	Option enables printing out the name of currently selected drying program.	Header
DRYING PROCESS PARAMETERS	Option enables printing out the printout of drying process parameters set for a given sample.	Header
VARIABLE 1	Option enables printing out VARIABLE 1.	Header
VARIABLE 2	Option enables printing out VARIABLE 2.	Header
VARIABLE 3	Option enables printing out VARIABLE 3.	Header
START MASS	Option enables printing out the net weight value in a basic unit (adjustment unit).	Header
EMPTY LINE	Option enables printing out the separating empty line.	Header Footer
TIME	Option enables printing out the drying time with preset interval during drying process.	GLP Printout

RESULT	Option enables printing out the drying result with preset interval during drying process.	GLP Printout
DRYING TIME AND RESULT	Option enables printing out the time and the drying result with preset interval during drying process.	GLP Printout
NET	Option enables printing out the net mass of a sample with preset interval during drying process.	GLP Printout
TARE	Option enables printing out the packaging mass with preset interval during drying process.	GLP Printout
GROSS	Option enables printing out the gross weight with preset interval during drying process.	GLP Printout
SET TEMPERATURE	Option enables printing out the temperature set in a particular stage of the drying process with preset interval during drying process.	GLP Printout
CURRENT TEMPERATURE	Option enables printing out current temperature read from the sensor with preset interval during drying process.	GLP Printout
PROGNOSIS	Option enables printing out current result prognosis (only when PROGNOSIS option is enabled)	GLP Printout Footer
STATUS	Option enables printing out the status of drying process summary (Completed/Aborted).	Footer
END DATE	Option enables printing out the end date of the drying process.	Footer
END TIME	Option enables printing out the end time of the drying process.	Footer
DRYING TIME	Option enables printing out the total time of the drying process.	Footer
END MASS	Option enables printing out the end mass of the tested sample.	Footer
RESULT	Option enables printing out the drying process result.	Footer
SIGNATURE	Option enables printing out an area for the signature of an operator carrying out the measurement.	Footer
NSD. PRN.	Option enables printing out one of 100 non-standard printouts. You can choose one of the following options: NONE / non-standard printout name. For instruction on how to enter non-standard printouts read later section of this user manual.	Header Footer

For the parameters described above, one of these values must be selected:
NO - do not print **YES** - print

An exemplary report printout is to be found in DRYING PROCESS section.

12.3. Other Printouts

HEADER	Group of parameters allowing you to declare variables that are to be printed on a header printout.	
GLP Printout	Group of parameters allowing you to declare variables that are to be printed on a measurement printout.	
FOOTER	Group of parameters allowing you to declare variables that are to be printed on a footer printout.	

Variables List

Variable	Description	Active for
WORKING MODE	Option enables printing out the working mode name printout.	Header Footer
BALANCE TYPE	Option enables printing out the balance type.	Header Footer
BALANCE S/N	Option enables printing out the balance serial number.	Header Footer
OPERATOR	Option enables printing out the logged-in operator name.	Header GLP Printout Footer
PRODUCT	Option enables printing out the currently selected product name.	Header GLP Printout Footer
CUSTOMER	Option enables printing out the currently selected customer name.	Header GLP Printout Footer
PACKAGING	Option enables printing out the currently selected customer name.	GLP Printout
DATE	Option enables printing out the printout date.	Header GLP Printout Footer
TIME	Option enables printing out the printout time.	Header GLP Printout Footer

VARIABLE 1	Option enables printing out the value of universal variable 1.	Header GLP Printout Footer
VARIABLE 2	Option enables printing out the value of universal variable 2.	Header GLP Printout Footer
VARIABLE 3	Option enables printing out the value of universal variable 3.	Header GLP Printout Footer
NET	Option enables printing out the net weight value in a basic unit (calibration unit).	GLP Printout
TARE	Option enables printing out the tare weight value in the current unit.	GLP Printout
GROSS	Option enables printing out the gross weight value in the current unit.	GLP Printout
CURRENT RESULT	Option enables printing out the current measurement result (NET weight value) in the current unit.	GLP Printout
MSW VALUE	Option enables printing out the minimum sample weight of a balance.	GLP Printout
MSW TARE	Option enables printing out the tare value for minimum sample weight.	GLP Printout
MASS TITRATOR FOR	Option enables printing out the net mass set for correct integration with titrators.	GLP Printout
ADJUSTMENT REPORT	Option enables printing out the most recent adjustment report printed according to the settings declared for the adjustment report printout (read section 11.1 of this user manual).	Header GLP Printout Footer
DASHES	Option enables printing out the line separating data and signature fields on a printout.	Header Footer
EMPTY LINE	Option enables printing out the blank separating line.	Header Footer
SIGNATURE	Option enables printing out an area for the signature of an operator carrying out the adjustment.	Footer
Profile	Option enables printing out selected profile name.	Header GLP Printout Footer
NSD. PRN.	Option enables printing out one of 100 non-standard printouts. You can choose one of the following options: NONE / non-standard printout name. For instruction on how to enter non-standard printouts read later section of this user manual.	Header GLP Printout Footer

For the parameters described above, one of these values must be selected:

NO - do not print **YES** - print

Printout examples:

```

-----
Mod pracy          Ważenie
Data              2016.07.06
Czas              10:51:05
Typ wagi          MAX2 NP
Id wagi           0
Użytkownik        AAAAAA
Towar             TTTTT

```

```

Data              04.06.2013
Czas              11:11:24 AM
Towar             NAZWA
0.000 g

```

```

Data              04.06.2013
Czas              11:11:24 AM
Użytkownik        Admin
Podpis
.....

```

12.4. Non-standard printouts

The program allows you to design 100 non-standard printouts. Each of them can consist of approximately 1900 characters.

Non-standard printout may include:

- variable data conditioned by a particular working mode and operator needs (mass, date etc.),
- fixed texts, entered into operator's menu,
- Non-standard printout can have approximately 1900 characters.

12.4.1. Inserting Texts

Variables List

<i>Symbol</i>	<i>Description</i>
{0} ¹⁾	Standard printout in an adjustment unit
{1} ¹⁾	Standard printout in a current unit
{2}	Date
{3}	Time
{4}	Date and time
{5}	Working mode
{6}	Net weight in a current unit
{7}	Net weight in adjustment unit
{8}	Gross weight in adjustment unit
{9}	Tare in adjustment unit
{10}	Current unit
{11}	Adjustment unit
{12}	Min threshold
{13}	Max threshold
{32}	Serial number
{45}	Target value
{46}	Tolerance
{50}	Product: Name
{51}	Product: Code
{52}	Product: EAN code
{53}	Product: Mass
{54}	Product: Tare

{56}	Product: Minimum
{57}	Product: Maximum
{66}	Product: Tolerance
{70}	Variable 1
{71}	Variable 2
{72}	Variable 3
{75}	Operator: Name
{76}	Operator: Code
{77}	Operator: Permissions
{80}	Packaging: Name
{81}	Packaging: Code
{82}	Packaging: Mass
{85}	Customer: Name
{86}	Customer: Code
{87}	Customer: TIN
{88}	Customer: Address
{89}	Customer: Postal code
{90}	Customer: City
{146}	Gross weight value in current unit
{147}	Tare in current unit
{150}	Paper crop for EPSON printer
{151}	Form feed for PCL printers
{155}	Integration with RADWAG CONNECT software
{275}	Date and time of ambient conditions readout
{276}	THB: Temperature
{277}	THB: Humidity
{278}	Internal sensor: Temperature 1
{280}	THB: Pressure
{281}	Air density

{284}	THB temperature from additional temperature sensor

{380}	Drying program: Name
{381}	Drying program: Code
{385}	Drying profile
{386}	Drying mode parameters
{387}	Finish mode
{388}	Finish mode parameters
{389}	Drying report: Unit
{390}	Drying report: Printout interval
{395}	Moisture analyzer: Set temperature
{396}	Moisture analyzer: Current temperature
{397}	Moisture analyzer: Drying time
{398}	Moisture analyzer: Status
{399}	Moisture analyzer: Drying time and result
{400}	Moisture analyzer: Humidity content - %M
{401}	Moisture analyzer: Dry content - %D
{402}	Moisture analyzer: Humid/Dry- %R
{403}	Moisture analyzer: Modulator
{404}	Moisture analyzer: Result control
{407}	Moisture analyzer: Drying chamber temperature (continuously displayed)
{408}	Moisture analyzer: Prognosis in a unit selected for printing drying process result

Caution:

- 1) *Format of variables {0} and {1} is finished with **CR LF** characters (i.e. switching to a next line is carried out automatically),*

Each of them can consist of approximately 1900 characters (letters, digits, special signs, spaces). You can apply non-standard characters, i.e. special signs, which allows you to print variable data.

Example:

„RADWAG”
DATE: <current measurement date>
TIME: <current measurement time>
PRODUCT MASS: <current mass indication>

*****SIGNATURE:.....
<current working mode>

Enter printout content settings and design the printout using respective data variables and characters for text format.

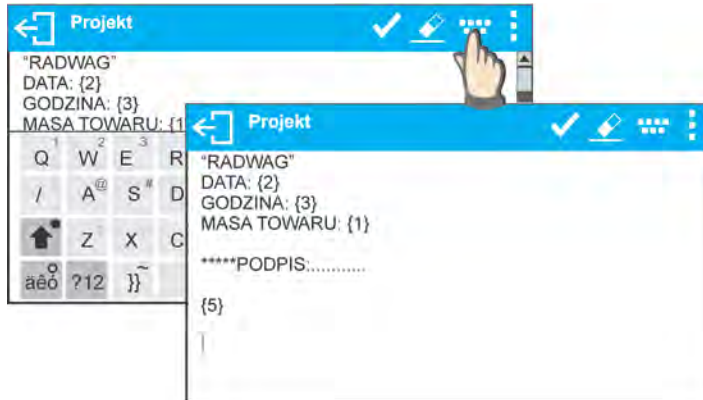

In order to carry out HEADER or GLP or FOOTER printout using EPSON printer (equipped with an auto-cutter blade) and crop the paper beneath the respective printout, select an option of non-standard printout comprising {150} variable, and set this option in header, GLP printout or footer settings, respectively. (For instruction on how to enter control codes, read section 21 of this user manual).

In such a case <SUFFIX> command must remain empty. Paper is to be cropped underneath the FOOTER.

Exemplary settings:

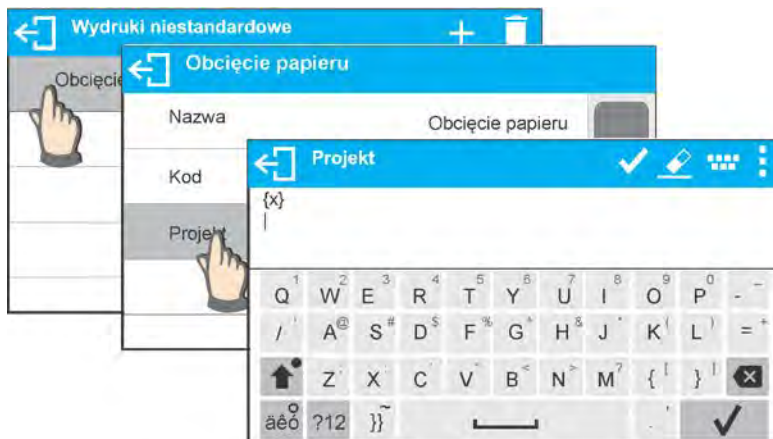

Method for inserting the text

- using moisture analyzer display
- by a computer keyboard of USB type

A computer keyboard of USB type can be connected to a moisture analyzer, this enables easier and quicker editing of the printouts. Willing to insert any text, it is necessary to select a respective menu option and, using the keyboard, type the text.

12.5. Variables



Variable is defined as alphanumeric data which can be linked to printouts, products or other information related to weighing. Every variable is characterized by its content, the content must be inserted. Variables are used for entering various data during the weighing process, e.g. serial number or batch number. The program allows to enter 3 variables. Each can consist of 31 characters maximum.

In order to insert a variable content, you need to enter variable settings (VARIABLE 1, VARIABLE 2, VARIABLE 3) and insert the respective values using arrow keys of the

moisture analyzer keypad or a computer keyboard. Procedure for entering text is the same as for non-standard printouts.

13. WORKING MODES – General Information

X2 series balances feature the following working modes:

	<p>Weighing Means of operation: weight of a load is determined through an indirect measurement. The moisture analyzer measures gravitational force which attracts the load. The obtained result is processed and displayed on the moisture analyzer screen in a digital format.</p>
	<p>Drying Means of operation: The moisture content value is obtained via evaporation of moisture from sample placed inside the drying chamber. The result is calculated automatically (and displayed) in real time, the calculation is made on the basis of sample mass at the beginning, in the course, and at the end of the process.</p>

Particular working modes feature specific settings. The settings enable adapting mode operation to your individual needs. They are activated upon selecting a respective profile. For detailed description of specific working mode settings refer to the given working mode section.

13.1. Working Modes Availability

This group of parameters allows you to declare which functions are to be accessible. You can deactivate functions that are not used in the course of moisture analyzer operation, to do it, set the accessibility parameter to **<NO>** value.

Procedure:

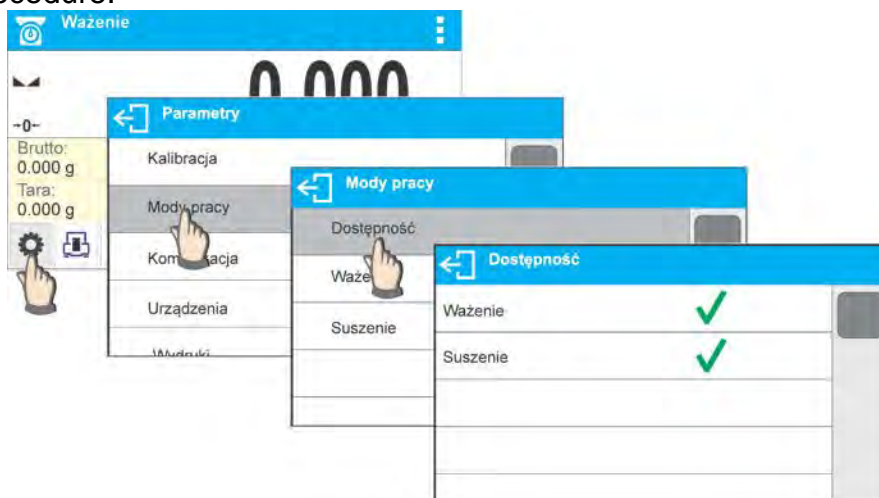

13.2. Running Working Mode

To run working mode other than currently operated one:

- o Press active working mode name.

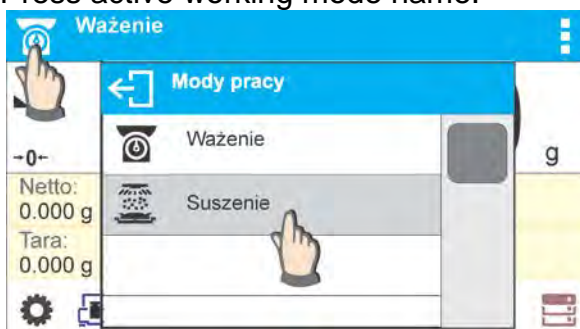

- o List of working modes is displayed.

- Select the mode that is to be operated.

13.3. Working Mode Parameters

Each working mode has programmable parameters determining its functioning. For overview of WEIGHING mode parameters, read section 9 of this user manual. Settings related to DRYING mode are to be found in respective sections describing particular working modes.

14. DATABASES

Weighing device software comprises the following databases :

- Products (5 000 records)
- Operators (100 records)
- Packaging (100 records)
- Customers (1 000 records)
- Drying programs (200 records)
- Drying process reports (5000 records)
- Ambient conditions (10 000 records)
- Weighings (50 000 records)

Caution:

It is not possible to edit some of the databases for a moisture analyzer integrated with E2R software. Use PC software to introduce modifications.

14.1. Database Connected Operations

The program enables the following operations to be carried out: adding new record, exporting data from databases, importing data to databases, deleting one record from the database, deleting all records from database, printing record data. Access to the above operations is conditioned by permissions levels.

Adding a New Record

Procedure:

- Enter database, press  pictogram located in the top bar.
- Define fields for the new record (data type is conditioned by a database).
- Database window is displayed, it features newly added record.

Export

Procedure:

- Connect the USB flash drive.
- Enter the database that is to be exported.
- Press  button located on the top.
- The program automatically saves exported data to a USB flash drive file, respective messages are displayed for confirmation of successfully completed operation.
- The file name is correlated with the name of exported database.

Database	File name and extension
Operators database	users.x2
Products database	products.x2
Packaging database	packaging.x2
Customers database	customers.x2

Drying programs database	programs.x2
Non-standard printouts	non_standard_printouts.x2

Import

Procedure:

- Save the file with database that is to be imported to a USB flash drive. Only files exported from other moisture analyzer that have proper names and extensions can be imported – see the above table.
- Connect the USB flash drive.
- Enter the database that is to be imported.
- Press  button located on the top.
- The program automatically reads the file and the data is imported to the moisture analyzer. Respective prompts are displayed for confirmation of successfully completed operation.



Delete a Record

To delete a record:

- Press and hold operator name.
- Message <Delete?> is displayed.
- Press <> button.
- The record gets deleted from the list.

Delete a Database

Procedure:

- Enter the database and press  button (Delete all).
- Message <Delete all records?> is displayed.
- Press <> button.
- Database content gets deleted.

DRYING PROCESS REPORTS and WEIGHINGS databases cannot be imported. DRYING PROCESS REPORTS database cannot be deleted. The database records can only be exported and saved to a USB flash drive. Names of files with exported data feature serial number and respective extension (see below table).

Database	File name and extension
Drying process reports	123456.dry
Weighings	123456.wei

Files can be read using **ALIBI Reader**, PC software designed by RADWAG. You can download the software from RADWAG website: www.radwag.pl.

AMBIENT CONDITIONS database serves informative purposes only. Using records preview option you can check ambient conditions and observe how they changed over time. The data saved to records can be printed by pressing  pictogram located in the top bar. Records names contain date and time of saving the record's data to moisture analyzer memory.

14.2. Products

Product database stores names of all products that can be weighed, counted, controlled.

List of parameters defined for a product:

1. Name
2. Code [product code]
3. EAN [Product EAN code]
4. Mass [Nominal sample mass]
5. Tare [Product tare value, set automatically when the product is selected out of the database]
6. Min [Low limit for product weighing in CHECKWEIGHING mode]
7. Max [High limit for product weighing in CHECKWEIGHING mode]
8. Tolerance [% value calculated in relation to mass, the parameter determines measuring area for which the measurement is recognized as correct for DOSING mode.]

14.3. Operators

Operators database features list of users permissioned to operate the weighing device.

Parameters defined for an operator:

- Name
- Code
- Password
- Permissions
- Language

14.4. Packaging

<Packaging> database contains list of packages for which a name, code and mass value are specified. When carrying out weighing process, upon selection of particular packaging, a respective tare value is triggered automatically. The tare value is displayed with minus sign.

Parameters defined for packaging:

1. Name
2. Code [internal packaging code]
3. Tare [packaging weight]

14.5. Customers

Customers database stores list of customers for whom the measurements are carried out.

List of parameters defined for a customer:

1. Name
2. Code [internal customer code]
3. TIN
4. Street
5. Postal code
6. City

14.6. Drying Programs

Drying programs database provides any data regarding the drying process.

List of parameters defined for drying programs:

1. Name
2. Code
3. Drying profile
4. Finish mode
5. Printouts
6. Sample mass control

14.7. Drying Process Reports

Drying process reports provide information about carried out drying processes. Each report can be previewed and printed.

Procedure:

- Enter  **Database**> submenu and press **<Drying process reports>** entry.
- Select report, if not visible, scroll the list using navigation buttons.
- Report is named by date and time; e.g. 2016.07.12 15:12:15.

List of formulations reports data:

1. Operator
2. Drying program
3. Start date
4. End date
5. Drying time
6. Status
7. End mass
8. Drying process status
9. Result

14.8. Ambient Conditions

Ambient conditions database contains parameters related to ambient conditions. Depending on the moisture analyzer type the ambient conditions report can show values of temperature, humidity, atmospheric pressure. If the given moisture analyzer is connected to a THB module then its indications are recorded to the database too.

Procedure:

- Enter  **Databases**> submenu and press **<Ambient conditions>** entry.
- Select the respective record, if not visible scroll the records list down.
- Record name includes data and time.

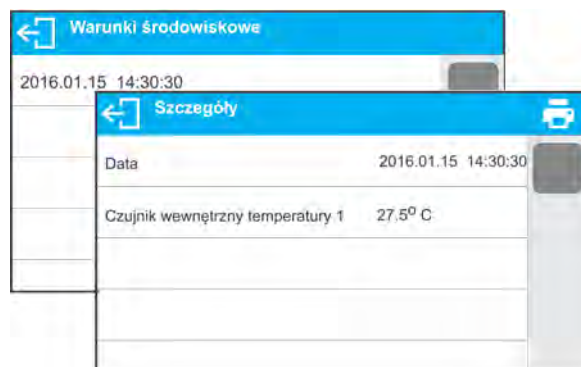

Caution: The software saves ambient conditions record in a so called loop, i.e. when the measurement 10 001 is saved, the measurement 1 gets automatically deleted from the moisture analyzer memory.

Records saved to moisture analyzer memory cannot be deleted.

14.9. Weighings

Each weighing result sent from the weighing device to a printer is saved to weighings database. You can preview data of particular weighings.

Procedure:

- Enter  **Databases**> submenu.
- Enter **<Weighings>** database and press respective record.

List of parameters for a weighing record saved to the database:

1. Performed weighing date
2. Performed weighing time
3. Result
4. Mass
5. Tare (packaging weight)
6. Operator
7. Product (product name)
8. Customer (customer name)
9. Packaging (name of tare applied during product weighing)
10. Working mode (working mode name)
11. Variable 1
12. Variable 2
13. Variable 3

15. SAMPLES PREPARATION

This section of user manual contains information about obtaining optimum test results during drying process. There are hints for selection of appropriate drying parameters for various materials and substances.

15.1. Moisture Content Measurement Principle for Moisture Analyzer

Measurement of sample moisture content is carried out by determining the loss of sample mass during heating (evaporation).

MAX2 moisture analyzer is comprised of two elements: a precision balance and a drying chamber. Compared to standard moisture content determining methods, the measurement with application of RADWAG moisture analyzer is much quicker and does not require additional mathematical calculations (a result of moisture content is previewed on an ongoing basis during product testing process).

Independently on moisture content determining method, the measurement accuracy is highly influenced by means of sample preparation and selection of testing parameters, such as:

- sample size
- sample type
- drying temperature
- drying time

In practice, the measurement accuracy is not as important as the speed of obtaining measurement result (control over technological process). Thus, heating a sample (with application of a halogen filament) carried out by a moisture analyzer, makes the measurement process very time efficient and short. Measurement speed can be additionally increased by appropriate adjusting moisture analyzer's parameters depending on tested substances.

Optimum temperature and drying time depend on sample type and size, and anticipated measuring accuracy. Selection of drying parameters can only be carried out on basis of test measurements.

15.2. Sampling and Preparation

Sample features, its preparation and size are very important factors influencing the speed and accuracy of measurement process.

Means of sampling and preparation are extremely important for repeatability of measurement results, as a sample should be a representative part of tested substance.



Final measurement result is vastly conditioned by precise and considered sample preparation. A sample used for analysis has to represent the total structure of tested material. Sampling process should determine: sampling means, sample disintegrating, particle size after disintegration, sample uniformity and other. The sampling process has to be carried out as quickly as possible, so that a sample does not lose or absorb moisture from surrounding area.

Applied sampling standards should match individual operator needs and requirements of tested material, its consistence and sample size.

Samples quantity

Increasing number of tested samples also increases statistic measurement certainty. Quantity of samples depends on uniformity of tested material, its purity, accuracy of applied measuring method and anticipated accuracy of obtained results.

Mechanical disintegration of the material intended for measurement

Applied disintegrating method should be selected appropriately to tested material. Substances that are hard and brittle (crisp) can be disintegrated by cutting. Grinding such substances may cause their heating and thus humidity vaporization, resulting in unreliable measurement results. Unless a substance can be prepared for measurement otherwise than grinding, any possible moisture content loss should be calculated.

Use of high-silica sand

Ensuring optimum substance drying requires that a sample has the largest possible surface for moisture content evaporation. Test results of moisture content for substance with surface in a form of a shell (e.g. glucose syrup) or doughy (e.g. butter), can be much more reliable if a sample is mixed with a dried high-silica sand (improvement of measurement accuracy and repeatability).

While using mixture, disposable weighing pan with extended brim must be applied (greater volume of a sample).

Grease in a form of paste or melting substances

Such substance requires testing with use of a filter made of glass fibre, which considerably increases active evaporation surface by separating the substance between the fibre. Initial filter drying is necessary only in case of measurements which require very high accuracy.

Liquid substances

It refers to liquid substances, which by creation of drops on their surface, caused by surface tension, may render difficulties in drying process. In such cases, use a glass fibre filter to shorten measurement time. The filter separates tested liquid around the fibres, and increases active evaporating surface. Initial filter drying is necessary only in case of measurements which require very high accuracy.

Leather-structure or temperature sensitive substances

In case of such substances use a glass fibre filter. While testing, a substance is placed on a drying pan, and sample surface is covered with a filter, which protects the sample from direct heat radiation. In such case, the sample is heated by convection (which is milder than radiation).

Substances containing sugar

The surface of such substances may caramelize during testing procedure. Therefore, it is recommended to use thin layer of a sample, and moderate drying temperature.

Sample distribution on a pan:

Loose substance

Dried in their natural state, i.e. in their natural form, or disintegrated. Sample disintegration causes smaller dispersion between the following measurements. Sample mass should not be too high. Evenly spread the sample on whole surface of the drying pan.

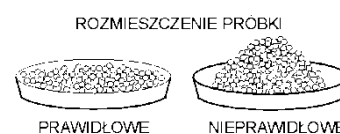

Liquid substances

Semi-fluid substances are dried in their natural form. Large amount of grease (fat) occurring in some of substances makes moisture content determination difficult. In such case it is recommended to use additional components, which increase sample's active surface and aid moisture content releasing process from a sample. Such components are: high-silica sand, blotting paper and filter. Prior to drying, initially dry the additional component, so that its humidity is close to zero.

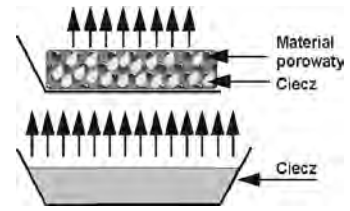

Solid substances

Depending on solid object's structure (dense or loose), moisture content determining process may take short or long time. The size of solid's surface determines the speed of drying process, and measurement reliability. Thus, the surface of a solid object should be as large as possible. Since solid objects release moisture through their outer surface, sample thickness is another important factor.

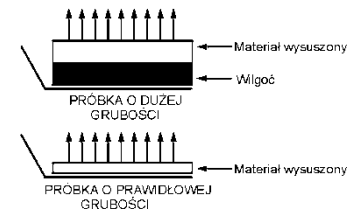

The distribution of the sample on the filter:

Spread the sample on the filter evenly with a spatula. Use the thinnest layer possible.



16. SELECTION OF DRYING PROCESS PARAMETERS

16.1. Optimum Sample Mass

Sample mass influences the accuracy of measurement result and measurement time. Higher mass of a sample causes higher amount of water (moisture content) which needs to evaporate, and therefore the measurement takes more time.

Obtaining short measurement time is possible in case of small sample mass, but sample mass cannot be too small, as it may negatively influence required measurement accuracy.

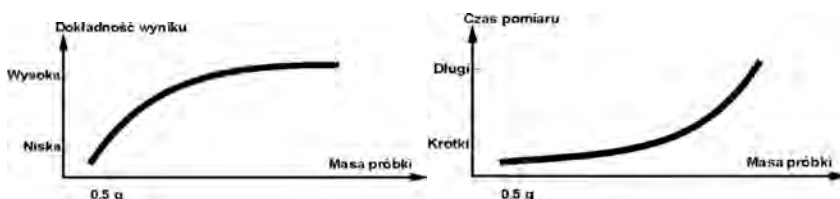

16.2. Influence of Sample Mass on Measurement Repeatability

Sample mass considerably influences repeatability of measurement results obtained on a moisture analyzer. Relation between sample mass and repeatability is presented in a table below.

Sample mass	Repeatability
~2 g	±0.05%
~ 10g	±0.01%

The above data refers to a model, uniform sample, containing no moisture due to the evaporation process and showing no signs of decomposition (e.g. wet high-silica sand).

The results uncertainty cannot be avoided, this is due to sample nature and moisture analyzer repeatability. In practice, it means that obtained measurement result may exceed repeatability values provided above.

16.3. Drying Temperature

Drying temperature has the largest impact on drying time. Temperature value depends on type of dried substance. Too low drying temperature causes too low moisture content evaporation (under-dried sample), and consequently unnecessary extending of measurement time. Too high drying temperature causes burning of dried sample (sample overheating, chemical decomposition). Drying temperature of traditional method (using a furnace) is specified in applicable industry or company standards. Unless standards apply, then temperature should be adjusted by tests.

When selecting drying temperature value, proceed as follows:

- Determine sample moisture content
- Determine temperature of substance chemical decomposition by tests
- Compare result obtained using a moisture analyzer with the one of traditional method

When drying a sample with high moisture content, it is possible to shorten measurement time by selecting quick or step drying mode. In such case, the majority of moisture content is released when the drying temperature is higher than set. Only after some time, the temperature is lowered to the set value, and maintained until completing drying process.

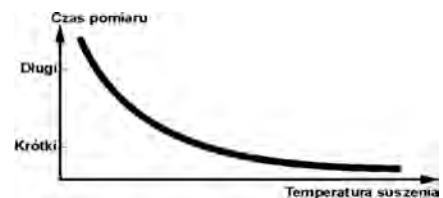

16.4. Drying Profile Selection

You can select one of four drying profiles:

- Standard
- Fast
- Mild
- Step

STANDARD profile

Standard profile is the most frequently used of all drying profiles. It enables accurate determining of moisture content in a dried sample.

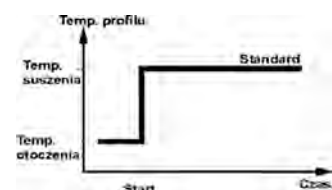

MILD profile

Mild profile is used in case of drying substances that are sensitive to rapid heat emitted by filaments operating at full power in the

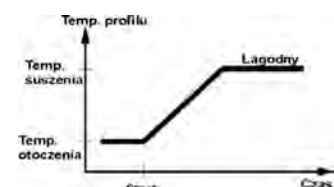

initial stage of drying process. This profile prevents from decomposing of substances sensitive to heat by mild temperature increase in set amount of time (time interval has to be selected by tests). Mild profile is recommended to drying samples of leather structure.

FAST profile

Fast profile is recommended to drying samples that moisture content varies from 5% to 15%. In the initial stage of Fast profile, heating takes place at full power of the filaments, causing heating the drying chamber to increased temperature, higher than the drying temperature. Overheating compensates heat loss during evaporation of large moisture content in the test's initial stage.

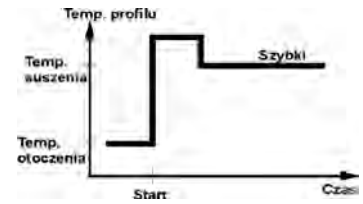

STEP profile

Enables determining up to three steps with random drying temperature. Step profile is recommended for drying substances with moisture content over 15%. Temperature and heating time in each step have to be adjusted by tests.

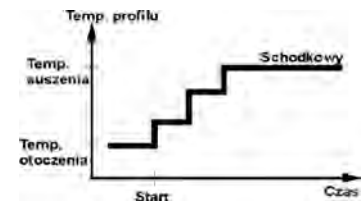

16.5. Drying Time

Drying time is set by selecting one of available finish mode criteria. This means that a moisture analyzer must meet pre-set criterion (mass over time, time) to automatically finish the drying process. Finish of drying process can be triggered by amount of time, independently on loss in mass. This criterion is used for substances that may decompose during drying process, and their mass does not reach constant value. The second criterion is loss in mass (less than 1 mg) in defined amount of time.

Finish modes:

Automatic- you can select various types of finish mode:

- Automatic 1 (change 1mg/10s).
- Automatic 2 (change 1mg/25s).
- Automatic 3 (change 1mg/60s).
- Automatic 4 (change 1mg/90s).
- Automatic 5 (change 1mg/120s).

Time defined- the drying process is finished after specified time, independently of the result. (max drying time 99hours 59minutes).

Manual- the operator ends drying process manually by pressing START/STOP key

User defined - criteria determined by the operator. The operator determines the limit value for loss of mass and time in which the loss of mass must not exceed a pre-set value. As the moisture analyzer reaches the set criterion it automatically finishes the drying process.

- User defined 1 (Δm – change of mass in mg and Δt – change of time in seconds, max 120 s)
- User defined 2 (set moisture content change ratio $\Delta \%M/60s$)

Test - (enables selection of the auto switch-off parameters for a given sample)

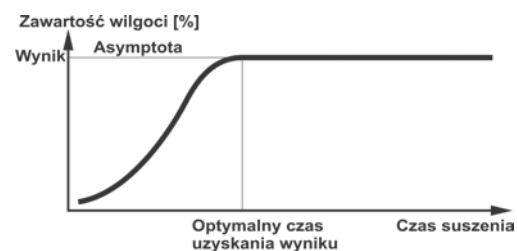

16.6. Drying Profile Analysis

For the first case, the drying profile is an asymptote. Moisture content value remains constant even after long drying time.

Using this drying profile, the drying process results are repeatable. The measurement result is always referred to constant value of asymptote.

The result corresponds easily and it is not difficult to select a proper criterion of finish mode.

For the second case the drying process is quick at the beginning, next it stabilizes. Moisture content value is never constant. The properties of the sample may cause it.

The sample undergoes thermal decomposition, wherein evaporation takes place and as a result the product weigh decreases. Evaporation of grease, oil, plastic or other volatile materials may take much more time than in case of water. Difficult to evaporate materials drop weight.

Result obtained using this mode may be optimized by:

- lowering drying temperature to slower the distribution of ingredients.
- selecting appropriate finish criterion, which enables to finish the drying process in an optimum point of the drying step,
- selecting constant drying time usually ensures correct and repeatable results,
- maintaining constant sample start mass.

17. DRYING

DRYING mode enables to determine moisture content of a given sample. The moisture content value is obtained via evaporation of moisture from sample placed inside the drying chamber. The result is calculated automatically (and displayed) in real time, the calculation is made on the basis of sample mass at the beginning, in the course, and at the end of the process.

Procedure for activation of Drying mode:

- Select <Drying> mode, the home screen is displayed automatically, wherein the top bar of the screen features  pictogram.

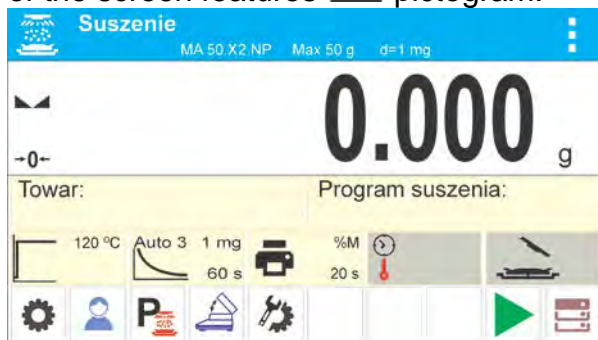

Info field provides the following information:

- Product
- Drying program
- Drying profile and drying temperature value
- Finish mode
- Printout parameters
- Info field displaying (in the course of drying) time and drying temperature values
- Info field displaying chamber status
- Buttons: parameters, user, drying program, open/close cover, drying mode settings, start, databases

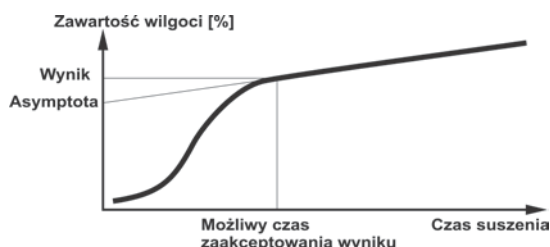

17.1. Safety Precautions During Drying

The moisture analyzer features two additional safety mechanisms.

- A. The first one informs the operator that the sample has fallen off the weighing pan during drying process and it is impossible to correctly determine its moisture content. In this case, the drying process is automatically aborted and an information window is displayed.

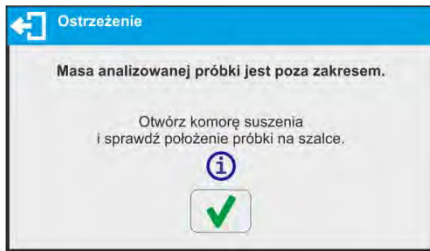

Follow the displayed prompt.

- B. The other mechanism protects the device and the operator against uncontrolled ignition of the sample during drying process.
- C. If the software detects a sudden increase of temperature above the set drying temperature, the drying is stopped, an information window is displayed and a sound signal is emitted.

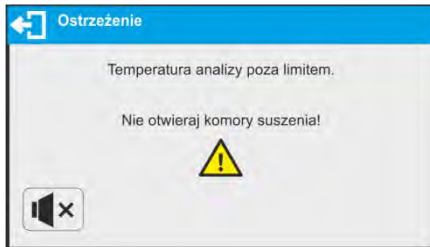

- D.
- E. Follow the displayed prompt. Wait until the temperature decreases to a safe level, which is signalled by a new prompt.

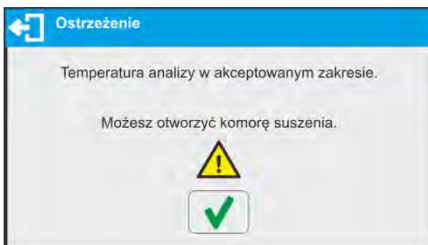

17.2. Mode Related Settings

The supplementary settings enable you to adjust the working mode to your needs and requirements.

Drying profile

Parameter enabling you to select respective drying profile and set drying temperature.

Finish mode

Parameter enabling you to select respective finish mode and set its parameters.

Printout parameters

Parameter enabling you to set the drying process unit for both the display and the printout, and measurement result printout interval during drying.

Prognosis

Parameter enabling to turn on/off result prognosis function.

Close the cover and turn the moisture analyzer off

Parameter enabling you to activate/deactivate auto opening/closing of the drying chamber's lid upon switching the moisture analyzer off by pressing  button.

Drying process wizard

Parameter enabling to turn on/off hints for the next steps at the drying process start.

For means of operation of the remaining functions read point 9.11 *WEIGHING Mode Settings*.

17.3. Drying – Quick Access Buttons

Each working mode features automatically displayed set of default buttons. The set can be modified, i.e. you can add out-of-list quick access buttons to it. Such operation requires particular permissions. List of quick access buttons is to be found in section 8.6 of this user manual.

18. DRYING PROCESS PERFORMED BY MEANS OF QUICK MENU



Default display in drying mode.

Current drying parameters are displayed in a form of pictograms in the middle of the workspace. To carry out drying process in accordance with other parameters, enter the settings and modify parameters. Press Settings pictogram to enter settings.

Prior to drying process start set the following parameters:

- drying profile and drying process parameters
- finish mode and finish mode parameters
- unit of a displayed and printed result
- interval of results printout during drying process

18.1. Drying Profile and Drying Process Parameters

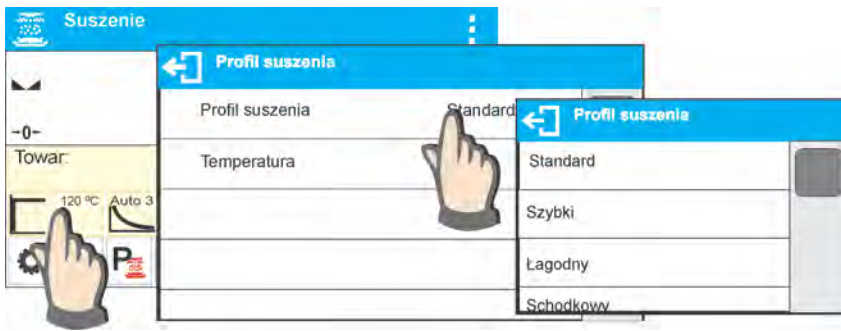

Enter drying profile settings and select respective drying profile. Upon selecting a profile, set its respective parameters. Parameters depend on selected profile.

Drying profile parameter's values:

- **STANDARD** drying profile
Set sample drying temperature.
- **FAST** drying profile
Set heating time (higher than drying temperature) and sample drying temperature.

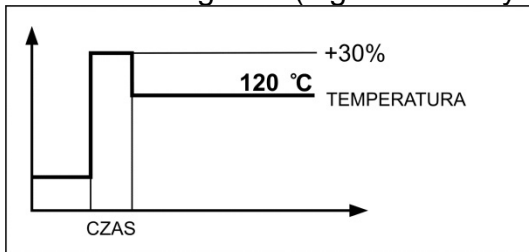

Specific feature of this drying profile is fast increase of drying temperature in short period of time. When compared to the preset temperature, the drying temperature rises 30% within 180 seconds and it is maintained at this level for a specified amount of time, next it drops to temperature value preset in drying profile parameters.

Caution:

For **Fast** profile set the drying temperature and heating time 30% higher than set temperature. Heating time is measured from the moment of reaching the set temperature. The device is designed in a way preventing from exceeding the maximum temperature. If for a moisture analyzer with maximum temperature of 160 °C a temperature higher than 112 °C is entered, the moisture analyzer will reach the maximum temperature of 160 °C, i.e. the temperature increase will be lower than 30% of the set temperature.

- **MILD** profile

Set time within which moisture analyzer is to reach specified temperature and sample drying temperature.

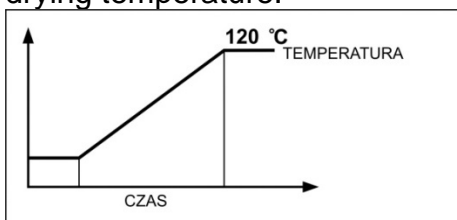

- **STEP** profile

Set: heating time for the first temperature, first step temperature, heating time for the second temperature, second step temperature, sample drying temperature.

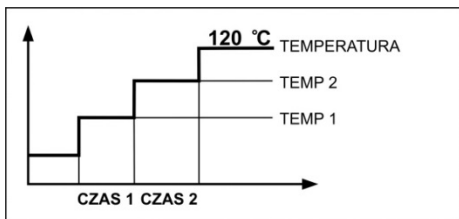

Caution:

For **Step** profile set step temperature „1” and „2”, drying temperature and heating time for step 1 and 2. Heating time is measured from the moment of reaching the set temperature for respective step.

18.2. Finish Mode



Finish mode parameter's values:

Automatic 1 - auto switch-off (1mg /10s),

Automatic 2 - auto switch-off (1mg /25s),

Automatic 3 - auto switch-off (1mg /60s),

Automatic 4 - auto switch-off (1mg /90s),

Automatic 5 - auto switch-off (1mg /120s),

Manual- manual switch-off (upon pressing **Start/Stop**, maximum drying time is 99 hours 59 minutes). Upon the elapse of pre-set time the moisture analyzer finishes drying process.

Time-defined- time-defined switch-off (maximum drying time is 99 hours 59 minutes).

Defined 1 - user-defined switch-off (change of mass comprised within the moisture analyzer range, set with moisture analyzer readability, time interval ranging from 1 to 120s).

Defined 2 - user-defined switch-off (change in humidity set with moisture analyzer readability, time interval ranging from 1 to 60s).

Test - (enables selection of the auto switch-off parameters for a given sample).

When drying using auto switch-off option, the printout contains information about time and results of respective auto switch-off cases. You can use them to determine required switch-off option (result and time).

Raport suszenia	
Data rozpoczęcia	2018.04.14
Czas rozpoczęcia	14:41:55
Użytkownik	AAAAAAAA
Towar	BBBBBB
Program suszenia	cccccc
Parametry suszenia	
Profil	Standardowy
120°C	120°C
Zakończenie	Test
Wynik	%M
Interwał	5s
Masa początkowa	0.796 g

0:00:05	0.537 %M
0:00:10	2.798 %M
0:00:15	4.182 %M
0:00:20	4.879 %M
0:00:25	5.593 %M
0:00:30	5.830 %M
0:00:35	5.830 %M
0:00:40 Zakończenie automatyczne 1	
Wynik :	5.830 %M
0:00:40 5.945 %M	
0:00:45	6.068 %M
0:00:50	6.068 %M

0:00:55	Zakończenie automatyczne 2
Wynik :	6.068 %M
0:00:55 6.068 %M	
0:01:00	6.068 %M
0:01:05	6.068 %M
0:01:10	6.068 %M
0:01:15	6.068 %M
0:01:20	6.068 %M
0:01:25	6.311 %M
0:01:30	6.311 %M
0:01:35	6.311 %M
0:01:40 Zakończenie automatyczne 3	
Wynik :	6.311 %M
0:01:40 6.311 %M	
0:01:45	6.311 %M
0:01:50	6.311 %M
0:01:55	6.311 %M
0:02:00	6.311 %M
0:02:05	6.311 %M
0:02:10 Zakończenie automatyczne 4	
Wynik :	6.311 %M

0:02:10	6.311 %M
0:02:15	6.311 %M
0:02:20	6.311 %M
0:02:25	6.553 %M
0:02:30	6.553 %M
0:02:35	6.553 %M
0:02:40	6.553 %M
0:02:45	6.553 %M
0:02:50	6.553 %M
0:02:55	6.553 %M
0:03:00	6.553 %M
0:03:05	6.553 %M
0:03:10	6.553 %M
0:03:15	6.553 %M
0:03:20	6.553 %M
0:03:25 Zakończenie automatyczne 5	
Wynik :	6.553 %M
Status	Zakończono
Czas suszenia	0:03:16
Masa końcowa	0.548 g
Wynik	31.156 %M

Podpis

18.3. Unit of a Displayed and Printed Result



g - mass change; measurement result is mass change recorded during drying process.
%M - percent loss of weight, displays weight change recorded during drying process expressed in percent,
%D - part of dry mass obtained during drying process, expressed in percent, measurement result is part of mass that is remaining on a drying pan after humidity content evaporation,
%R - humid / dry ratio obtained as a result of drying process, expressed in percent, measurement result is part of mass that evaporated from the dried sample during drying process,

18.4. Printout Interval

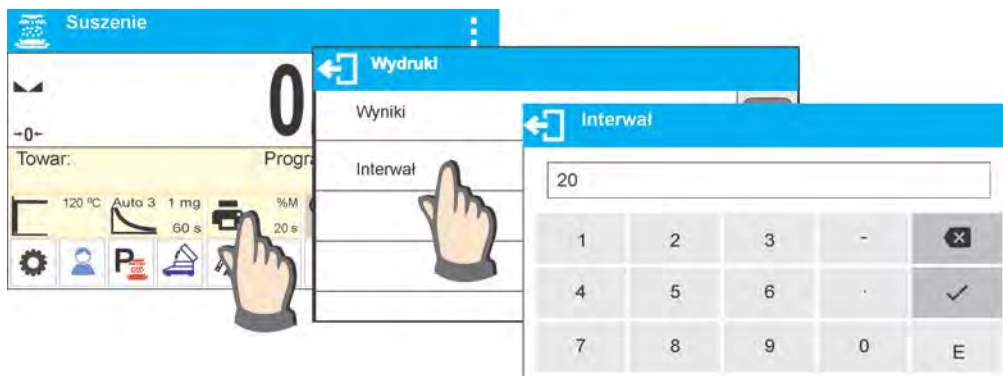

The time interval between printouts in seconds ranging from 0 to 120.

18.5. Drying Process Wizard

Parameter enabling to turn on/off hints for the next steps at the drying process start.

Procedure:

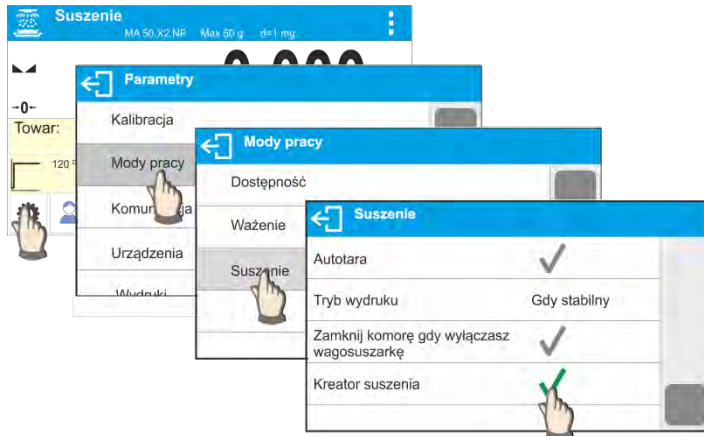

Enable the function to activate drying process wizard. The wizard guides you through all steps of setting the drying parameters. Only after setting confirmation the moisture analyzer will start the process of sample preparation and drying.

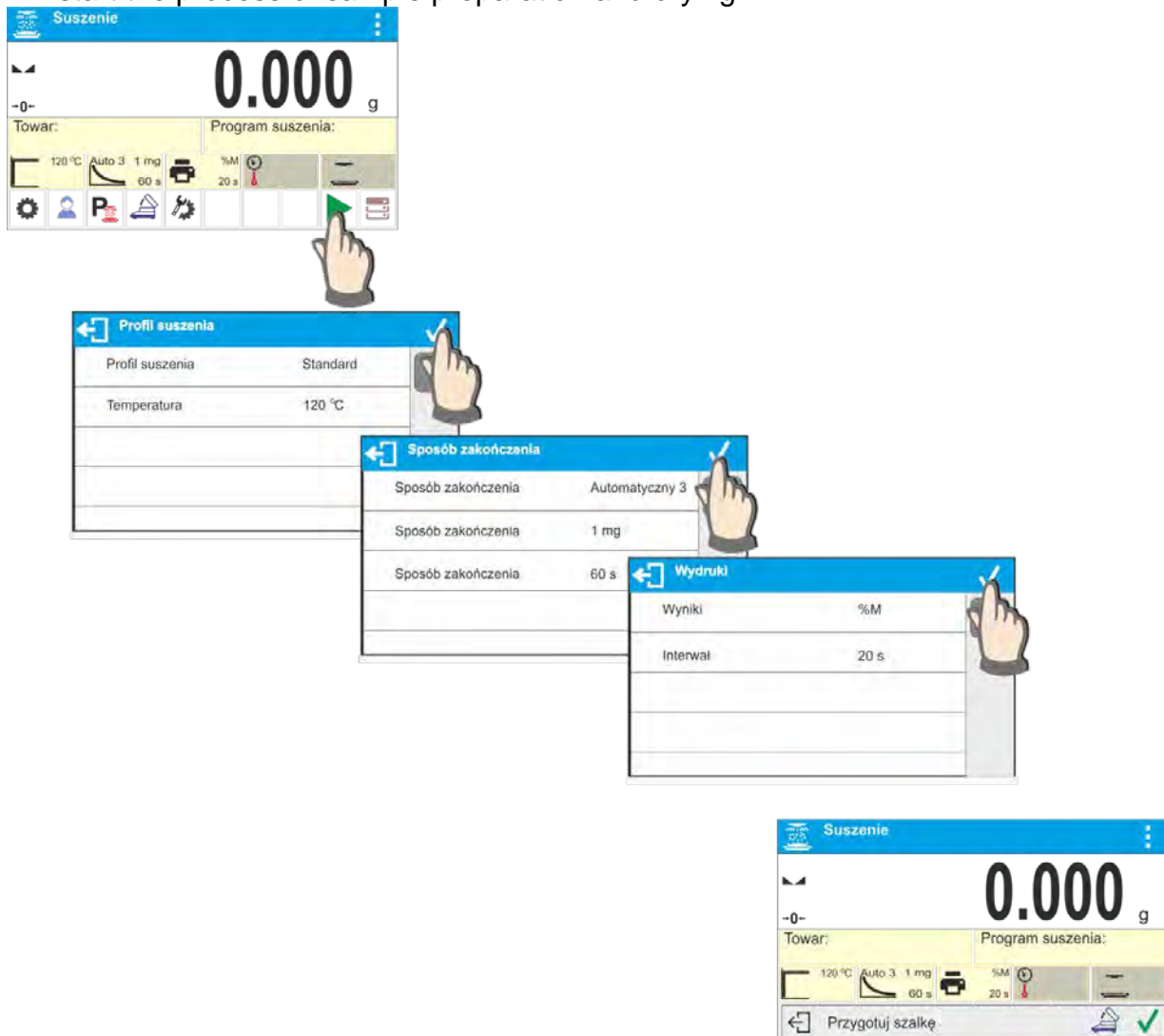

Caution:

The option can be enabled only when there is no drying mode selected from the database.

19. DRYING PROCESS USING DRYING PROGRAMS DATABASE

The moisture analyzer can store up to 200 drying programs that can be configured, saved and used after selecting required program.

Procedure:

1. Enter the procedure to moisture analyzer database (refer to section 14. *Databases*).
2. Select entered program prior to drying process start. Drying parameters get updated to parameters saved for a selected drying program.





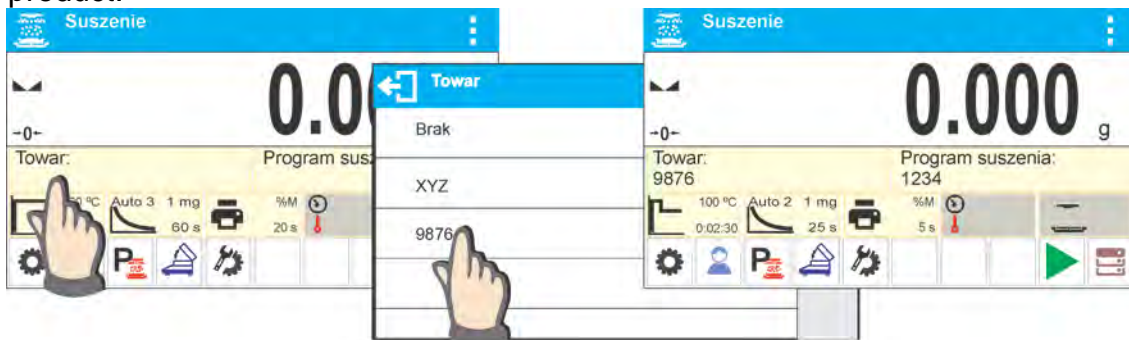

Or:

3. Enter data concerning product/sample that is to be dried. In product data set entered program as the drying program (refer to section 14 *Databases*).
4. Select the entered product as current prior to drying process. Drying parameters get updated to parameters saved for a selected drying program assigned to a given product.

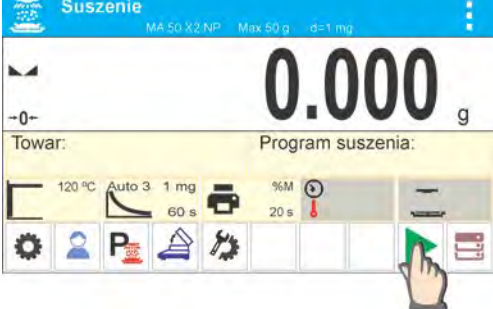

20. DRYING PROCESS

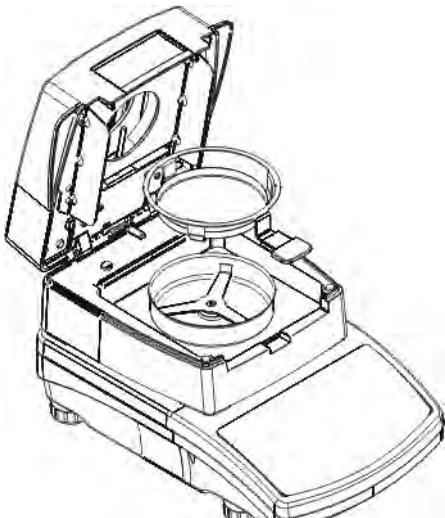
CAUTION: Make sure to carefully close and open the drying chamber to reduce the risk of air drafts that may change the position of the sample or rapidly supply oxygen and initiate or increase the burning of the sample.

	<p>Drying process settings are displayed in the information field above the buttons.</p>
	<p>Press Start button to start drying process. If the drying chamber's lid is closed, it gets opened automatically. Prompts and messages are displayed making moisture analyzer operation easier. Follow the displayed prompts to correctly prepare the sample and to perform the process of humidity content determination for a tested sample.</p>
	<p>Program prompts you to prepare a weighing pan. A respective pictogram on drying chamber status is displayed.</p>
	<p>Place the disposable weighing pan in a pan handle and set it on a cross-shaped holder. The display shows disposable pan weight.</p> <p>It is recommended to close the drying chamber in order to provide stable ambient conditions while taring, to do it press  button.</p>

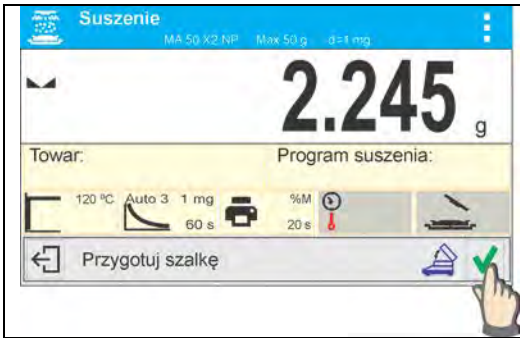

Press  button to zero the weighing pan weight.



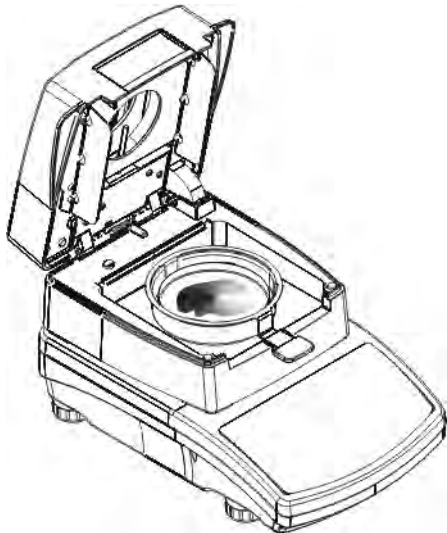

Indication equals ZERO, drying chamber's lid gets opened automatically, subsequent prompt is displayed and the pictogram on drying chamber status changes.

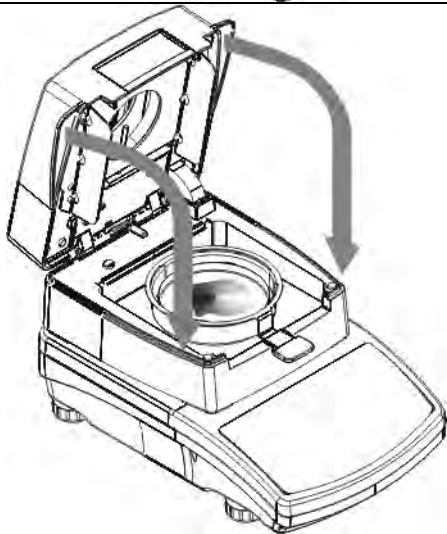

Load the weighing pan with the sample. Sample mass shall be selected on the basis of prior experience and tested material characteristics.



Upon sample preparation and result stabilization press  button to confirm sample preparation completion. Drying chamber's lid gets closed automatically, the drying process starts. Press  button to close the drying chamber. This also triggers the drying process start.

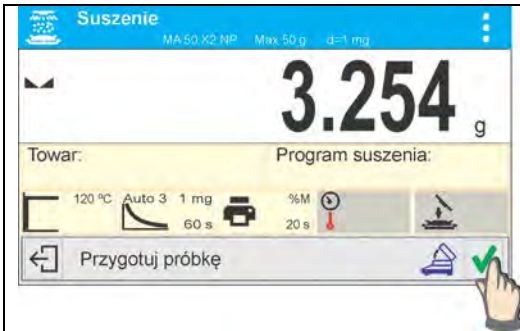

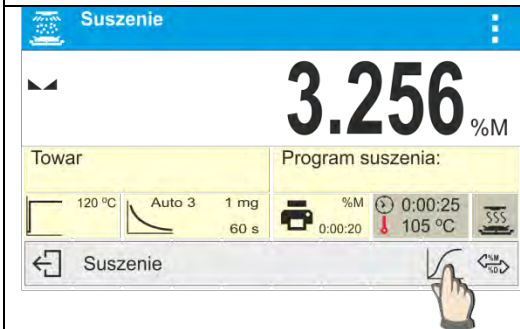

Information on the drying process is displayed, moisture analyzer proceeds to carrying it out accordingly to set parameters. Required mass measurements and calculations of tested sample moisture content are performed, wherein the calculations are a result of mass change. Upon process start, printout header is sent to a selected interface (accordingly to set printout options – parameter group DRYING PROCESS REPORT/HEADER).

CAUTION: To stop the drying process, e.g. as a result of some danger, press  button located on the bottom bar. The process is stopped immediately and the sample is no longer heated.

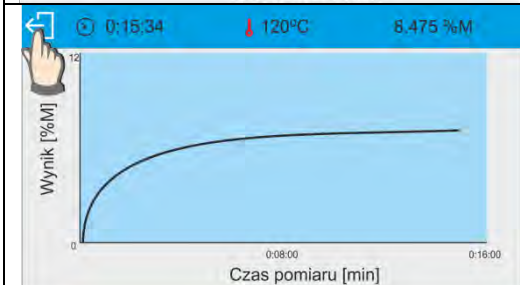
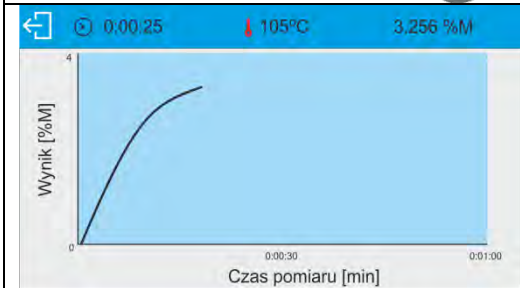

Press  button to preview drying process graph.



Press  button to return to the home screen.

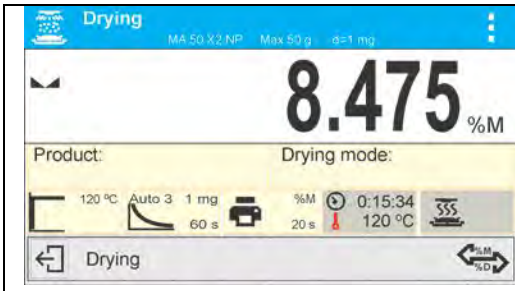



In course of a drying process current weight results and information on the process is displayed (test duration, drying chamber temperature, etc.). In course of a drying process (accordingly to set printout options – parameter group DRYING PROCESS REPORT/MEASUREMENT) measurements are sent to a selected communication port in a preset time intervals (INTERVAL).

Press  to swap between displayed result types.



Upon drying process completion, summary of the test is displayed, final moisture content result is held, drying chamber's lid gets opened automatically. Upon process stop, printout footer is sent to a selected interface (accordingly to set printout options – parameter group DRYING PROCESS REPORT/FOOTER).

Drying process can be aborted at any time. Press  button to abort the drying process and press  button to confirm.

Manual auto switch-off mode is an exception to the rule – for moisture analyzer working in this mode, the drying process ends upon pressing  button. There is no need to confirm by pressing  button.

Drying report is printed again by pressing  button.

The report is automatically saved to reports database.

Press  button to return to home screen. Moisture analyzer returns to its initial state, completed process summary is blanked. The moisture analyzer is ready to perform another test.

Exemplary report:

-----Drying process report-----	
Start date	2015.07.08
Start time	12:28:13
Balance type	MAX2 NH
Balance Id	123456
User	AAAAAA
Product	xxxxxxx
Drying mode	ABCD
-----Drying process parameters-----	
Drying profile	Standard
100 °C	
Finish mode	Automatic 3
1 mg/60s	
Indication	% M
Interval	10s
Start mass	0.459 g

0:00:00	0.000 %M
0:00:10	0.583 %M
0:00:20	2.524 %M
0:00:30	4.272 %M
0:00:40	5.049 %M
0:00:50	5.631 %M
0:01:00	5.825 %M
0:01:10	5.825 %M
0:01:20	5.825 %M
0:01:30	5.631 %M
0:01:40	5.631 %M
0:01:43	5.437 %M
Status	Completed
End date	2016.07.08
End time	12:29:55
Drying time	0:01:42
End mass	0.487 g
Indication	5.437 %M
Signature	
.....	

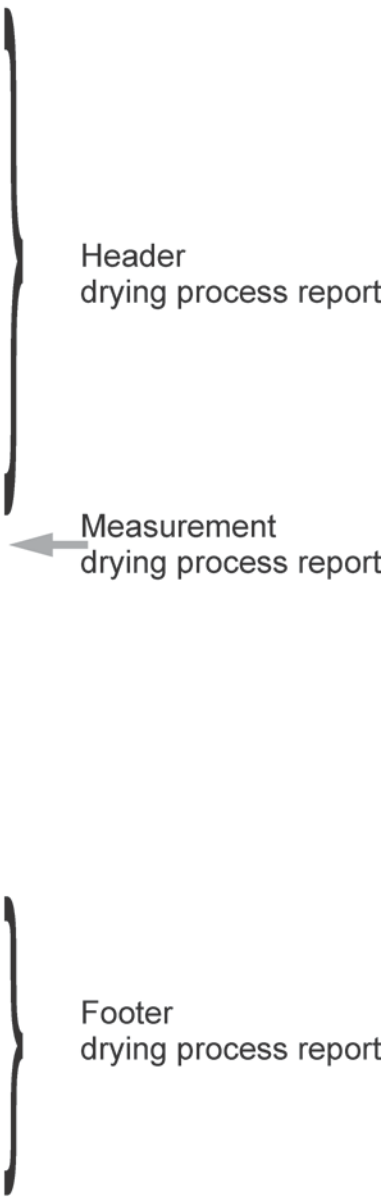

20.1. End Result Prognosis

This option enables estimating end result before drying process is completed. Based on characteristics of current drying curve, created online, moisture analyzer estimates the end result of drying process. It is an approximate result characterized with small error (about +/- 10% of the end result for most of the products and +/- 20% for products that require drying process to be longer such as: plastics, gels and materials containing more than 30% of water). This option is useful for users who need faster estimation of the drying process end result. The time of the prognosis process ranges between 15% and 40% of the standard drying time.

Caution: Do not open the weighing chamber during drying process while using prognosis option. It may distract the process and the calculations would be incorrect. Prognosis is finished when the drying chamber is opened and a suitable message is displayed.

Prior drying process using prognosis option, set the following parameters.

2. Enable prognosis option in accordance with the following instructions:

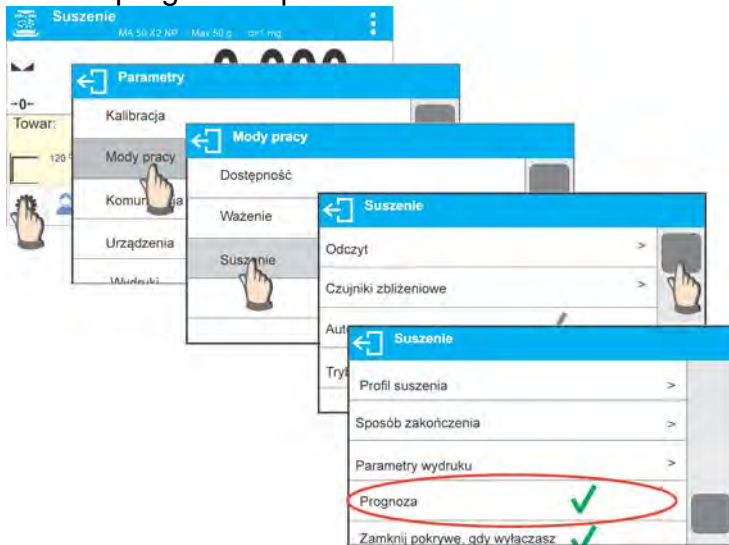

3. In accordance with description in point 8.6.2, place the label with displayed prognosis on the home screen.

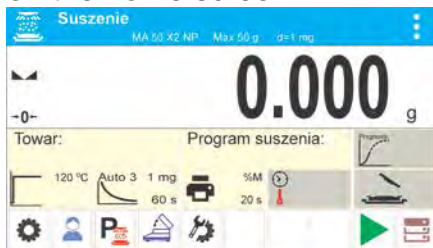

4. If the prognosis is to be printed with the measurement, enable its printing in the following settings: PRINTOUTS/ DRYING PROCESS REPORT /MEASUREMENT/PROGNOSIS.

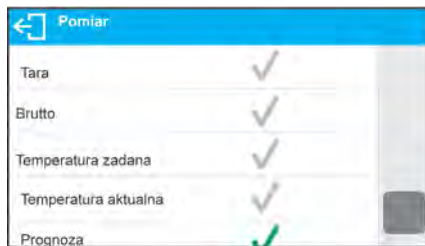

5. On setting the above parameters you can start drying process by following the above description. On starting the drying process an additional button is displayed in the bottom part of the display. On pressing this button, a window with prognosis is displayed. In the initial stage of the drying process there is no result of prognosis yet and the <Calculating> status is displayed in the prognosis window.

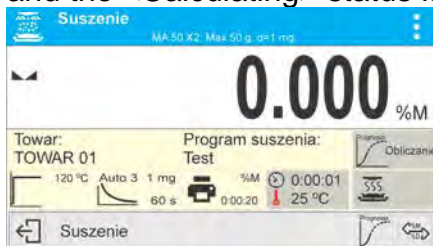

6. When the intersection of the drying curve is found, the end result can be estimated. When calculated, it is displayed in the prognosis label.

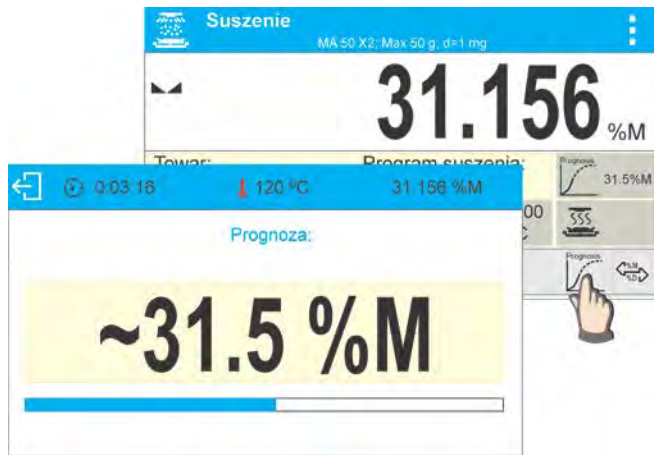

7. If the result of prognosis meets your expectations, you can abort the drying process before its completion. To do that, return to home screen and press  button.

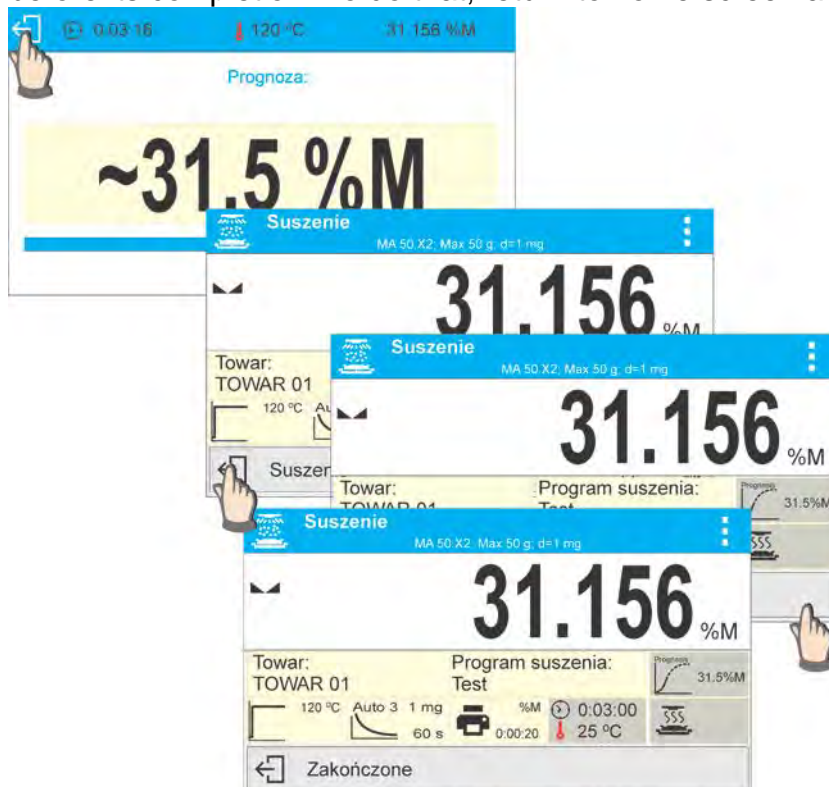

8. On drying process completion a footer of drying report containing status, end result and estimated result are printed. The estimated result is a result that would be achieved on reaching the criteria set by the user for a given process.

An exemplary report from drying process containing prognosis result:

----- Raport suszenia -----			
Data rozpoczęcia	2016.11.14	0:01:20	21.859 %M
Czas rozpoczęcia	14:41:55	Prognoza	35.1 %M
Użytkownik	Kowalski Jan	0:01:40	26.256 %M
Towar	TOWAR 01	Prognoza	35.1 %M
Program suszenia	Test	0:02:00	29.020 %M
----- Parametry suszenia -----		Prognoza	35.3 %M
Profil	Standardowy	0:02:20	30.528 %M
120°C		Prognoza	35.3 %M
Zakończenie	Auto3	0:02:40	31.030 %M
1mg/60s		Prognoza	35.3 %M
Wynik	%M	0:03:00	31.156 %M
Interwał	20s	Prognoza	35.5 %M
Masa początkowa	0.796 g	0:03:16	31.156 %M
-----		Status	Przerwane
0:00:00	0.000 %M	Czas suszenia	0:03:16
Prognoza	--- g	Masa końcowa	0.548 g
0:00:20	1.508 %M	Wynik	31.156 %M
Prognoza	--- g	Prognoza	31.5%M
0:00:40	7.412 %M	Podpis	
Prognoza	--- g	
0:01:00	15.578 %M		
Prognoza	--- g		

21. COMMUNICATION

Communication menu is located in <Parameters> menu. It is accessed by pressing  button. Communication between the PUE C315 indicator and the peripheral devices is established via the following ports:

- COM 1 (RS232),
- USB 1 type A
- USB 2 type B
- Ethernet,
- Wi-Fi.

In order to set the ports go to <Communication> submenu.

Press  key, next select „Communication” parameter group.

21.1. RS232

Procedure:

- Select <COM1> communication port
- Configure ports.

Transmission parameters for RS 232 ports:

- Baud rate - 2400, 4800, 9600, 19200, 38400, 57600, 115200 bit/s
- Parity - None, Odd, Even

21.2. ETHERNET Settings

Procedure:

- Select <Ethernet> port, set respective transmission parameters:
 - DHCP - Yes / No
 - IP Address - 192.168.0.2
 - Subnet mask - 255.255.255.0
 - Default gateway - 192.168.0.1

Caution:

Above settings are for information purpose only. Set the transmission parameters in accordance with your local network.

Return to weighing mode and restart the device.

21.3. Wi-Fi Settings

Caution:

1. *Set the transmission parameters in accordance with your local network.*
2. *For correct communication via Wi-Fi, set port parameter for computer to <WIFI> value: <PERIPHERALS/COMPUTER/PORT/WIFI>, next set the parameters as described below.*

Moisture analyzer equipped with Wi-Fi module features a respective pictogram at the home screen in the top right-hand corner:

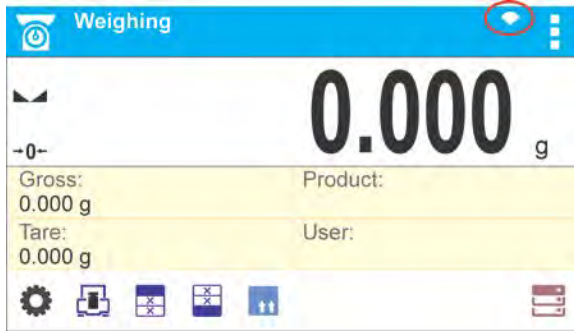

Pictogram for Wi-Fi network connection status:

No.	Pictogram	Description
1		The weighing device is connected, very strong signal
2		The weighing device is connected, strong signal
3		The weighing device is connected, poor signal
4		The weighing device is connected, very poor signal
5		No connection (signal too poor, selected network unavailable, connection parameters invalid – password, IP etc.)

Exemplary settings for Wi-Fi port:

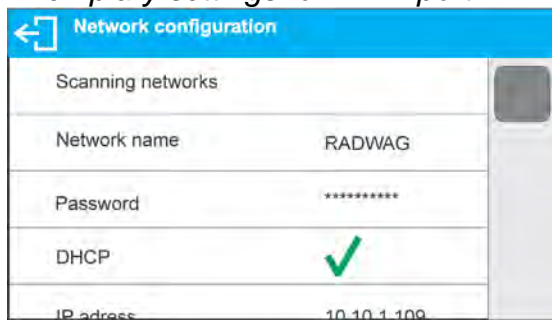

Caution:

Above settings are for information purpose only. Set the transmission parameters in accordance with your local network.

Procedure:

- Select <WIFI> communication port

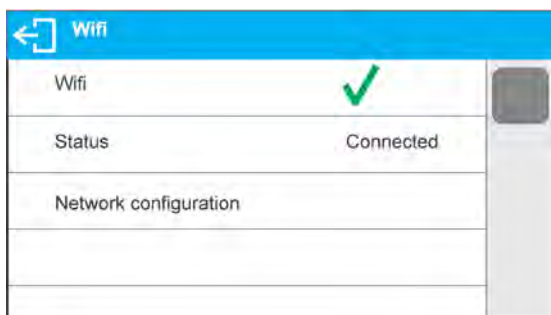

- Enter <NETWORK CONFIGURATION> parameter and set DHCP parameter value:

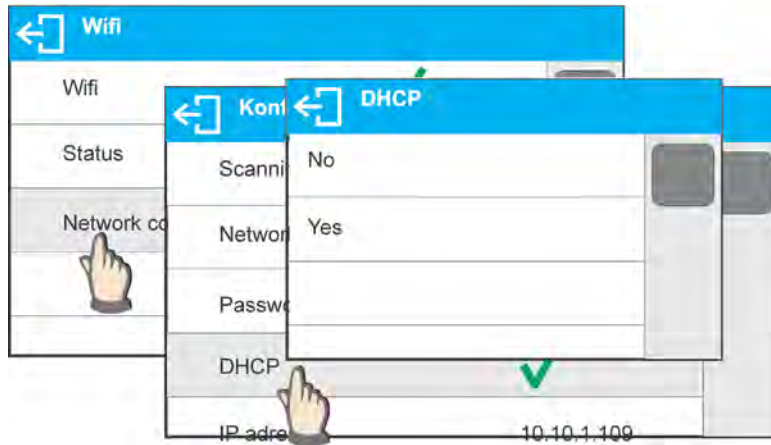

With DHCP set to NO value, enter manually: <IP>; <MASK>; <DEFAULT GATE> parameters.

With DHCP set to YES value, the moisture analyzer software automatically reads and displays data assigned by Wi-Fi router by means of which the moisture analyzer is to be connected,

- Enter <SCANNING NETWORKS> parameter and start network searching procedure. Upon completion, list of detected networks is displayed along with information on signal strength and channel number.

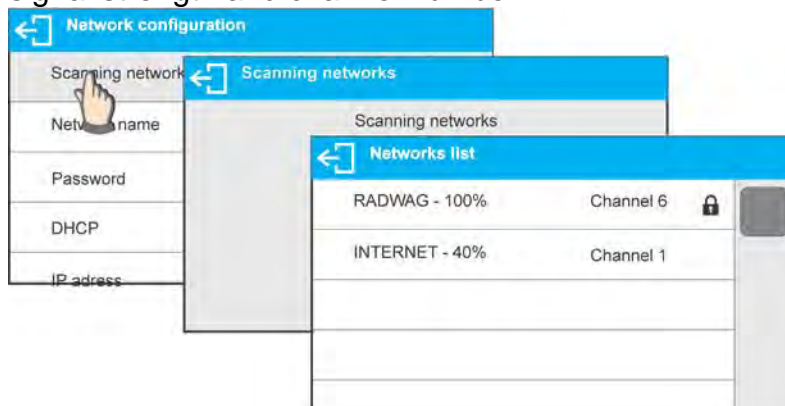

- Select network of your choice.
- Password window is displayed, enter the password using an on-screen keyboard.



- <NETWORK CONFIGURATION> window is displayed, connection procedure starts automatically.
- Press  key to return to the previous window. <STATUS> parameter features <CONNECTING> sign, operation of connecting the moisture analyzer to the network is in progress.
- For successfully established connection <CONNECTING> status turns to <CONNECTED> status, respective pictogram is displayed (see pictogram overview above).
- If you are waiting too long for the communication to be established it means that incorrect parameters must have been entered (e.g. password).

- If you fail to establish the communication, contact RADWAG service team.

The selected network and settings of parameters for connection are stored in moisture analyzer memory. The moisture analyzer connects to the network in accordance with these settings each time it is switched on.

To disconnect the network turn the communication off:

COMMUNICATION/WIFI/WIFI – NO



21.4. USB Ports

USB 1 port of type A is intended for:

- connecting a USB flash drive storing <**FAT files system**>,
- connecting moisture analyzer to PCL printer,
- connecting EPSON TM-T20 printer to USB port.

USB flash drive may be used for printing data on measurements (setting PRINTER/PORT parameter to PENDRIVE value). Measurement data printout operation is described in section 21.3. of this service manual. Additionally, databases (for description of this function go to section 14 of this service manual) and user's parameters settings can be copied balance to balance. Upon inserting USB flash drive, an Export/Import group of parameters opens automatically. If you are authorized you can:

Export: databases, user's parameters

Import: databases, user's parameters

During export the software saves files with databases and parameters content to a flash drive. The exported data can be imported to any X2 series balance.

Please remember that in case of PCL printer, completely filled page is printed. This means that in order to print the page, it is necessary to press PRINT key, located on the operation panel, for several number of times (printout size determines how many times the PRINT key must be pressed prior printout).

It is possible to obtain printout upon pressing PRINT key once only, supposing that control code <0C> has been set as SUFFIX (for description of this function go to section 21.2 'Printer').

USB 2 port of type B is intended for:

- connecting moisture analyzer to a PC.



In order to make connection of moisture analyzer and computer possible, it is necessary to install virtual COM port in a computer.

To carry out this procedure, you need a respective driver installer which may be either downloaded from the website www.radwag.pl or taken from a CD storing the manuals: *R X2 SERIES RADWAG USB DRIVER x.x.x.exe*.

Steps:

1. Run driver installer.

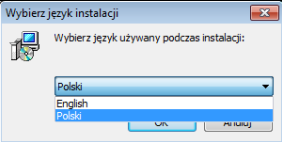
Start-up dialog window:

	<p>Select language version.</p>
	<p>In order to continue, press 'Next' button.</p>

Window for selecting installation path:

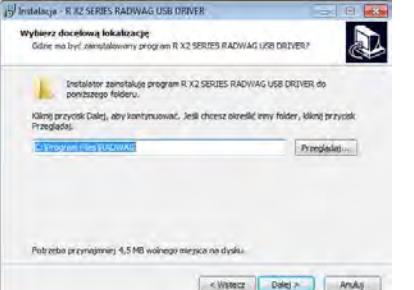
	<p>Select a respective folder and click 'Next' button to proceed.</p>
---	--

'Ready to Install' window:

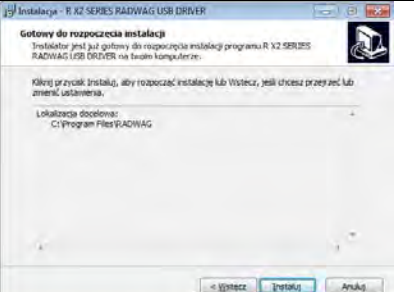
	<p>In order to run installation process, press „Install” button and clicking respective keys, follow the install wizard.</p>
---	---

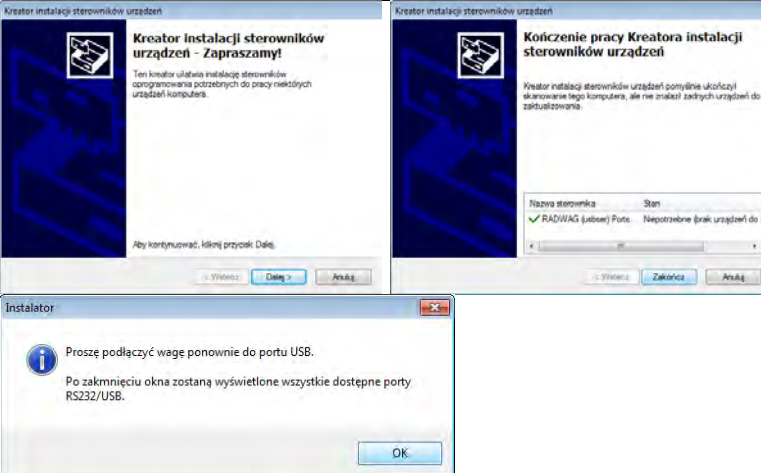

- Having completed driver installation, connect the moisture analyzer to a computer, use maximum 1.8-meter long USB A/B cable (if the moisture analyzer is already connected, disconnect it, next reconnect it using USB cable).



3. The system detects the new USB device and automatically starts searching for a respective driver.
4. Go to Device Manager and check number assigned to virtual COM port.

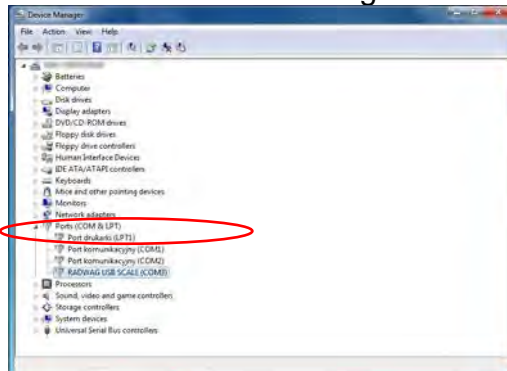

For this very case it is STMicroelectronics Virtual COM Port (COM8).

5. Set moisture analyzer parameters: select USB B value for COMPUTER/PORT parameter.
6. Run software for measurements readout.
7. Set communication parameters – select COM port that was installed in the course of drivers installation (in this very case it is COM8).
8. Start integration.

22. PERIPHERALS

<Peripherals> menu is located in <Parameters> menu. It is accessed by pressing  button. Peripherals menu provides list of devices that can be integrated with the moisture analyzer.

22.1. Computer

Carry out configuration using <Computer> submenu.

Procedure:

- Press  button, next press: <Peripherals / Computer>.
- Set parameters related to compatibility with a computer.
- Select computer port:
 - Available options: none, COM 1, COM 2, USB, Ethernet, Wi-Fi, USB Free Link

Caution: In order to set USB Free Link instead of USB select any other port (e.g. none, COM1, etc.) and next select USB Free Link port. Analogously when changing USB Free Link to USB.

USB FREE LINK - USB port, type B, for connecting a computer. Tool for entering data, it functions as a keyboard. Upon proper modification of non-standard printout and sending proper command from the computer, or upon pressing ENTER key located on the operation panel, the data from non-standard printout is entered directly to computer programs, e.g. Excel, Word, Notepad etc. Select <USB FREE LINK> port and configure its settings in order to enable correct compatibility of the moisture analyser with computer programs:

SPREADSHEET - value YES --.-- - compatibility with Excel type program, (.) dot is used as decimal point while sending the mass value
- value YES --,-- - (,) - comma is used as decimal point while sending the mass value
- value NO - compatibility with other programs (mass value is sent as a text,

DELAY – if the transferred information is incomplete, i.e. part of it gets lost (due to auto-entering or auto-formatting of data by computer program) during integration with Excel type program, set the parameter value to <2>. If the transferred information is still incomplete, the parameter value must be higher. The value ranges between 0 (quick data transfer) and 9 (slow data transfer – around 10 characters per second).

In case of Free Link printout (keyboard emulator) all languages without special characters are operated ('QWERTY' keyboard layout). These languages do not use special characters.

Additionally, the following languages are operated:

- Polish for 'Polish (Programmers)' keyboard. To enable support of this language go to printer settings on your moisture analyzer and select Windows-1250 code page (Central European, Latin-2). The following Polish diacritical signs are added: ą, ć, ę, ł, ń, ó, ś, ź, ż.

- German for 'German (Germany)' keyboard. To enable support of this language, go to printer settings on your moisture analyzer and select Windows -1252 code page (Western European, Latin-1). The following German diacritical signs are added: ä, ö, ü, ß. The keyboard layout changes from 'QWERTY' to 'QWERTZ'. The characteristic feature of such keyboard is 'ß' sign located on the right side of the 'zero'.

Caution: Free Link printout option allows printing only signs that are available on a keyboard. Entering capital letters and special signs, by means of key combination where "Shift" key is pressed, is also possible. In case of Polish and German, basic special characters (written using key combination of a given letter and right 'Alt' button) were added. Free Link printout option does not support printing of remaining special signs.

- Port settings

- Settings related to a port selected for computer connection.

CAUTION:

For Ethernet and Wi-Fi® port, Timeout parameter is on. The parameter specifies time delay, i.e. time interval for disconnection, counted from the moment of the most recent command sent from the device to which the moisture analyzer is connected.

Timeout parameter value has to be entered in milliseconds [ms].

- E2R

- Available options: YES/NO.

E2R System performs supervision and control over all weighing processes carried out using mass comparator. With E2R system activated some databases can be operated using computer exclusively (access to specified functions and options using weighing instrument is not possible).

To start integration with E2R system, set <E2R> parameter to <YES> value, as a result a respective pictogram is displayed in the top bar:



Caution: Turn the continuous transmission off in order to provide correct integration with E2R system.

- Address:

- parameter for setting address of moisture analyzer connected with a computer

- Weighing printout template

- parameter enabling you to design customized printout, for this, use window with printout template. For more information on designing printouts read section 11.2 of this user manual.

- Continuous transmission, parameter enabling to turn on/off continuous transmission of a weighing result. Available options:

- continuous transmission in calibration unit, indications are transmitted in the main unit (adjustment unit) independently from currently operated unit of mass,
- continuous transmission in current unit, indications are transmitted in a currently operated unit of mass, the transmitted unit changes along with the current unit change (Units key),
- continuous transmission turned off: <NONE>.

Caution: Continuous transmission can be turned on/off by a respective message sent from a computer (read: COMMUNICATION PROTOCOL).



- Printout interval

Parameter enables setting printout frequency for continuous transmission. Printout frequency is set in seconds, with 0.1s accuracy. Time values range between 1000s. and 0.1 s. The setting is valid for continuous transmission in calibration unit and in current unit activated by means of the moisture analyzer. It is also valid for continuous transmission activated by a command sent from a computer.

22.2. Printer

Submenu <Printer> enables you to select a port to which data is to be sent upon pressing  key. Content of sent data is set in <PRINTOUTS/GLP PRINTOUTS> parameter.

Procedure:

- Press  button.
- Enter <PERIPHERALS> menu.
- Enter <PRINTER> submenu.
 - set moisture analyzer parameters related to integration with the printer: <PORT> to which the printout is to be sent upon pressing  key (printer connected). Available options:

Caution: In order to set USB Free Link instead of USB select any other port (e.g. none, COM1, etc.) and next select USB Free Link port. Analogously when changing USB Free Link to USB.

COM 1 – RS 232 port, the one to which a printer is connected

USB – USB 1 port, type A, for connecting a PCL or EPSON printer,

Ethernet – port for transferring data from moisture analyzer to a dedicated RADWAG software, e.g. PW-WIN, operated on a computer connected to a moisture analyzer via network.

PENDRIVE – USB 1 port, type A, for connecting USB flash drive. PENDRIVE option requires setting format for saved file. You can save the data in the following formats: *.txt format (text file that can be opened on the computer using Notepad), or *.csv format (file that can be opened using Excel).

WIFI – port intended to enable sending data to RADWAG manufactured software PW WIN (opened on computer connected to moisture analyzer via Wi-Fi), to printer featuring Wi-Fi port or to network printer.

USB PC – USB 2 port, type B, for connecting a computer with a dedicated RADWAG software, e.g. PW-WIN.

USB FREE LINK - USB port, type B, for connecting a computer. Tool for entering data, it functions as a keyboard. Upon proper modification of non-standard printout and sending proper command from the computer, or upon pressing ENTER key located on the operation panel, the data from non-standard printout is entered directly to computer programs, e.g. Excel, Word, Notepad etc.

Select <USB FREE LINK> port and configure its settings in order to enable correct compatibility of the moisture analyzer with computer programs:

SPREADSHEET - value YES --- - compatibility with Excel type program, (.) dot is used as decimal point while sending the mass value

- value YES --,-- - (,) - comma is used as decimal point while sending the mass value
- value NO - compatibility with other programs (mass value is sent as a text,

DELAY – if the transferred information is incomplete, i.e. part of it gets lost (due to auto-entering or auto-formatting of data by computer program) during integration with Excel type program, set the parameter value to <2>. If the transferred information is still incomplete, the parameter value must be higher. The value ranges between 0 (quick data transfer) and 9 (slow data transfer – around 10 characters per second).

In case of Free Link printout (keyboard emulator) all languages without special characters are operated ('QWERTY' keyboard layout), These languages do not use special characters.

Additionally, the following languages are operated:

- Polish for 'Polish (Programmers)' keyboard. To enable support of this language go to printer settings on your moisture analyzer and select Windows-1250 code page (Central European, Latin-2). The following Polish diacritical signs are added: ą, ć, ę, ł, ń, ó, ś, ż, ź.
- German for 'German (Germany)' keyboard. To enable support of this language, go to printer settings on your moisture analyzer and select Windows -1252 code page (Western European, Latin-1). The following German diacritical signs are added: ä, ö, ü, ß. The keyboard layout changes from 'QWERTY' to 'QWERTZ'. The characteristic feature of such keyboard is 'ß' sign located on the right side of the 'zero'.

Caution!

Free Link printout option allows printing only signs that are available on a keyboard.

Entering capital letters and special signs, by means of key combination where "Shift" key is pressed, is also possible.

In case of Polish and German, basic special characters (written using key combination of a given letter and right 'Alt' button) were added.

Free Link printout option does not support printing of remaining special signs.

An exemplary measurement printout is described in the PRINTOUTS section.

Additionally you can send a controlling code (of a hexadecimal form) to a printer either at the beginning of the printout - <PREFIX> parameter, or at the end of it - <SUFFIX> parameter. Sending these codes allows to control globally information and actions carried out at the beginning and/or at the end of each printout sent from a weighing device to a printer.

This function is most frequently used:

- to send information about the code page of a printout sent by a moisture analyzer, at the beginning, and

- to send a command enabling the crop of a paper in EPSON printers (if the printer is equipped with an auto cutter blade), at the end.

Settings of <Prefix> and <Suffix> parameters are valid for all printouts sent via the weighing device, e.g.: adjustment reports, statistics etc., and header, footer and GLP printouts.

Caution:

It must be remembered that inserting paper crop command to <SUFFIX> parameter (control code) results in sending the code after each printout. If you wish for one whole printout to consist of: HEADER, GLP PRINTOUT and FOOTER and to be cropped underneath the FOOTER, then the paper crop command should be inserted only for FOOTER settings as a

non-standard printout with <{150}> variable (paper crop for EPSON printer). In such a case <SUFFIX> command must remain empty.

To ensure correct integration of the moisture analyzer with the printer (correct printout of diacritical signs of a given language), respective baud rate, obligatory for a given printer, must be selected (read the printer settings). Additionally code page of a sent printout must be accordant with a code page of a printer.

There are two methods for obtaining code page accordance:

- by setting the right code page in the settings of a printer (read printer's user manual) – it must be accordant with the printout code page of a moisture analyzer:

<i>Code page</i>	<i>Language</i>
1250	POLISH, CZECH, HUNGARIAN
1251 or 866	RUSSIAN
1252	ENGLISH, GERMAN, FRENCH, SPANISH, ITALIAN
1254	TURKISH
1256	ARABIC

- by sending the control code from the weighing device, which, prior the printout, automatically sets the right code page of the printer, i.e. code page accordant with the one of a weighing device (Read user manual of the printer you operate to check if it supports this option).

CAUTION: CODES MUST BE ENTERED IN A HEXADECIMAL FORM!

Exemplary moisture analyzer settings for correct integration (printout of Polish signs) with EPSON thermal printer connected to RS232 port:

1. EPSON TM-U220D

Communication parameters for port to which the printer is connected:

- *baud rate* – 9600 bit/s
- *parity* – none

Printer parameters set for PERIPHERALS group:

- *port* – COM 1 or COM 2 (the one to which the printer is connected)

- *code page* – **852**

2. EPSON TM-T20

Communication parameters for port to which the printer is connected:

- *baud rate* – 38400 bit/s
- *parity* – none

Printer parameters set for PERIPHERALS group:

- *port* – COM 1 or COM 2 (the one to which the printer is connected)

- *code page* – **1250**
- *prefix* – **1B742D**

Printer's parameters:

- *port* – COM 1 or COM 2 (the one to which the printer is connected)

- *code page* – **852**
- *prefix* – **1B7412**

If on the printout in the place of the last digit there are any unexpected signs (for verified moisture analyzers), then <CONTROL CODES> parameter must incorporate, apart from

the code page, code of the UK signs chart: **1B5203**. In such case the <CONTROL CODES> parameter setting has to be as follows:

prefix – **1B74121B5203**

Control codes for exemplary code pages:

Control code	Page or other command
1B7412	Code page 852
1B7411	Code page 866
1B742D	Code page 1250
1B742E	Code page 1251
1B7410	Code page 1252
1B7430	Code page 1254
1B7432	Code page 1256
1B7433	Code page 1257
1B5203	UK signs chart
1B5202	DE signs chart
1D564108	Paper crop
0C	Form feed (for PCL printers)

22.3. Record of Measurement Data Onto a USB Flash Drive

The moisture analyzer software enables record of measurement data onto an external flash drive.

Procedure:

- Plug a USB flash drive into USB 1 port, type A.
- Enter <PERIPHERALS/PRINTER/PORT> submenu and set <PENDRIVE> value.
- Set file format: *.txt or *.csv
- Return to weighing.
-  key, when pressed, provides record of measurement data (specified for GLP PRINTOUT), wherein the data is saved in a form of a text file, created automatically by moisture analyzer software; The file name is: *printout.txt*.
- Remove the USB flash drive from a moisture analyzer's USB port after about 10s counting from the last measurement record, only after this time the data is saved. Next plug the USB flash drive to a computer and read the saved text file using Notepad or Excel.

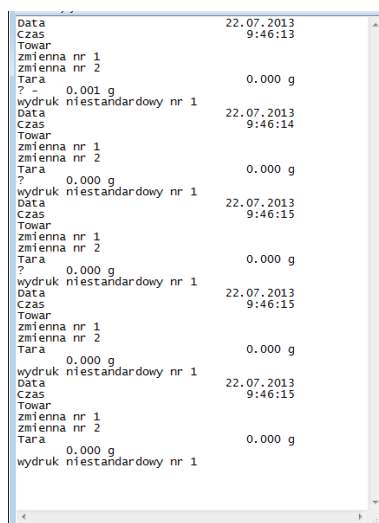
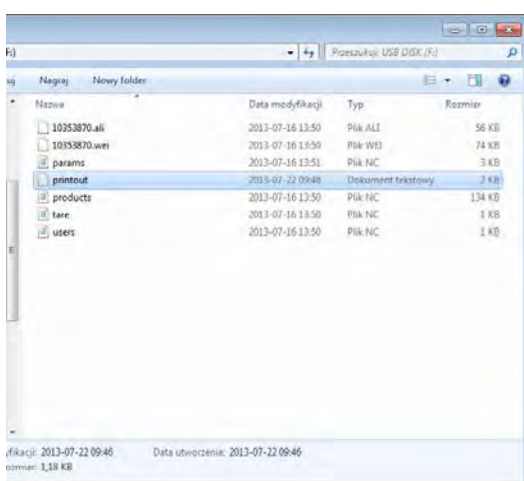

The data can be printed using any computer-connected printer. It is possible to overwrite the file with new data therefore you can continue recording measurement data using the file once created.

Caution: USB flash drive must comprise <FAT files system>.

22.4. Barcode Scanner

The moisture analyzer enables integration with a barcode scanner. The barcode scanner is used to facilitate quick search for database records. To configure connection settings of the barcode scanner enter <Settings/Peripherals/Barcode scanner> submenu.

Operator can:

- a) select communication port to which barcode scanner is connected,
- b) set parameters of selected port.

Caution:

Enter <Communication> submenu or barcode scanner settings and set baud rate for a barcode scanner (by default 9600 b/s).

Procedure:

- Press  button.
- Enter <PERIPHERALS> menu.
- Enter <BARCODE SCANNER> submenu.
- Set moisture analyzer parameters related to compatibility with the barcode scanner:
 - <PORT> - selection of port for connecting the barcode scanner:
 - Available options: NONE, COM 1.

22.5. Ambient Conditions Module

Ambient conditions module (THB 3/5) can be connected to the moisture analyzer via COM 1 port. In order to provide correct integration enter connected module address and baud rate for the port (port settings) to which the ambient conditions module is connected (the address and baud rate data is to be found on an ambient conditions data plate).

Exemplary settings for ambient conditions module port:

Baud rate – 115200 bit/s; Address – 15.

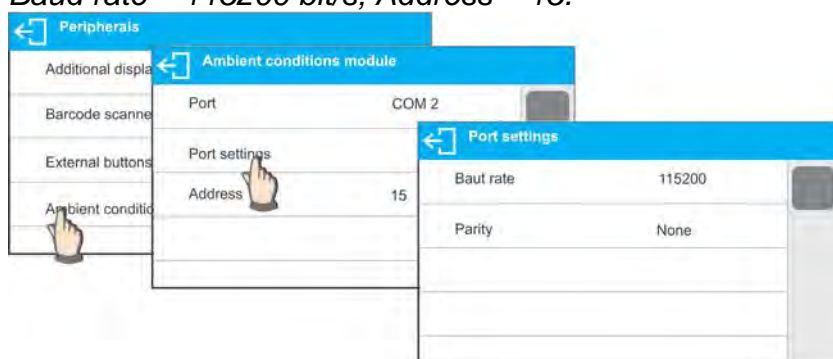

23. AMBIENT CONDITIONS

Parameters group which has been designed to enable you to turn on readout of ambient conditions recorded by the ambient conditions module (THB 3/5). Using this submenu, you can also specify tolerance high and low threshold of both temperature and humidity, and a change rate for these values per hour. The entered values are referred to indicted ones. Next on the basis of values comparison respective pictograms are displayed informing you whether the sensor-read values are comprised within permissible limits or not. Particular sensors settings:

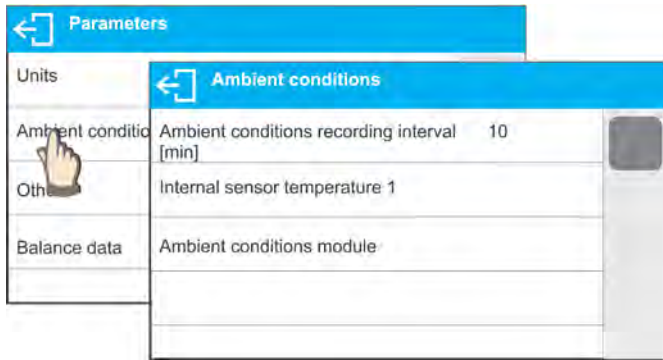

- Ambient conditions recording interval [min]: parameter enabling you to specify record frequency of sensor-registered data, and to determine how often the displayed pictograms (providing information on ambient conditions state) are to be refreshed,
- Internal sensor 1: enter this parameter to specify tolerance temperature values and moisture analyzer temperature change rate.

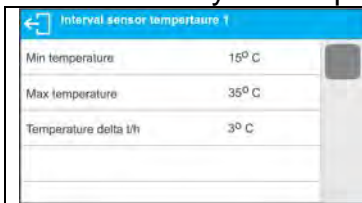

Min temperature – min moisture analyzer temperature, for lower temperature values the thermometer pictogram is red.

Max temperature – max moisture analyzer temperature, for higher temperature values the thermometer pictogram is red.

Temperature delta t/h – maximum moisture analyzer temperature change rate, for higher change rate the moisture analyzer displays blinking red thermometer pictogram.

In order to enable/disable parameter visibility go to service menu.

- Ambient conditions module: parameters group which has been designed to enable you to turn on readout of data recorded by a moisture analyzer-connected ambient conditions module, and to specify tolerance values for this module.

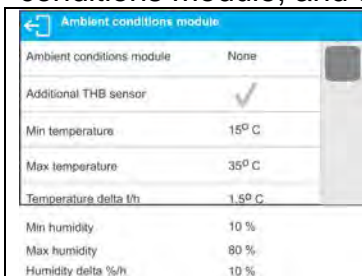

Ambient conditions module - parameter specifying module's working mode. Available options: **None** – readout of ambient condition module's indications turned off; **Record** – readout and record of indications into module's database turned on; **Record and alert** – readout and record of indications into module's database turned on, option of display of warnings informing on ambient conditions change turned on (the warnings are displayed on the basis of tolerance high and low thresholds).

Additional temperature sensor – turning on readout of indication of the additional temperature sensor connected to the ambient conditions module.

Min temperature – minimum temperature value, for lower temperature values the thermometer pictogram is red.

Max temperature – maximum temperature value, for higher temperature values the thermometer pictogram is red.

Temperature delta t/h – maximum temperature change rate, for higher change rate the moisture analyzer displays blinking red thermometer pictogram.

Min humidity – minimum humidity value, for lower humidity values the pictogram is red.

Max humidity – maximum humidity value, for higher humidity values the pictogram is red.

	Humidity delta %/h – maximum humidity change rate, for higher change rate the moisture analyzer displays blinking red pictogram.
--	---

With all the parameters set, the home screen displays respective pictograms informing on current ambient conditions values and their change.

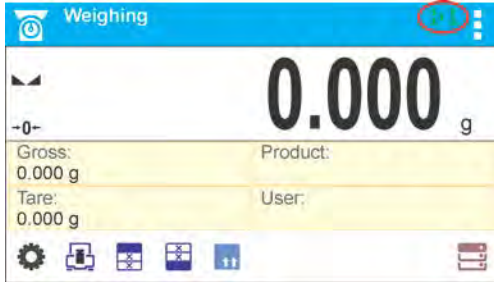

Pictograms for ambient conditions state:

No.	Pictogram	Description
1		Indicated temperature is within specified permissible limits
2		Indicated temperature is out of specified permissible limits
3		Indicated humidity is within specified permissible limits
4		Indicated humidity is out of specified permissible limits
5		Temperature change rate is to high (blinking pictogram)
6		Humidity change rate is to high (blinking pictogram)

24. COMMUNICATION PROTOCOL

General Information

- A. A character based communication protocol (moisture analyzer-indicator) is designed for establishing communication between a RADWAG moisture analyzer and a peripheral device.
- B. The protocol consists of commands sent from a peripheral device to the weighing instrument and responses from the weighing instrument.
- C. Responses are sent from the weighing instrument each time a command is received.
- D. Commands, forming the communication protocol, enable obtaining data on weighing device status and facilitate influencing weighing device operation, e.g.: acquiring measurement results from the weighing device, zeroing, etc.

24.1. List of Commands

Command	Command overview
Z	Zeroing
T	Taring
OT	Give tare value
UT	Set tare
S	Send stable measurement result in basic measuring unit
SI	Immediately send measurement result in basic measuring unit
SU	Send stable measurement result in current measuring unit
SUI	Immediately send measurement result in current measuring unit
C1	Switch on continuous transmission in basic measuring unit
C0	Switch off continuous transmission in basic measuring unit
CU1	Switch on continuous transmission in current measuring unit
CU0	Switch off continuous transmission in current measuring unit
DH	Set min checkweighing threshold
UH	Set max checkweighing threshold
ODH	Give value of min checkweighing threshold
OUH	Give value of max checkweighing threshold
SM	Set mass value of a single item
TV	Set target mass value
RM	Set reference mass value
NB	Give moisture analyzer serial number
SS	Value release
IC	Internal adjustment performance
IC1	Disable automatic internal adjustment of the moisture analyzer
IC0	Enable automatic internal adjustment of the moisture analyzer
K1	Lock moisture analyzer keypad
K0	Unlock moisture analyzer keypad
OMI	Give available working modes
OMS	Set working mode

OMG	Give current working mode
UI	Give accessible units
US	Set current unit
UG	Give current unit
BP	Activate sound signal
PC	Send all implemented commands
BN	Give moisture analyzer type
FS	Give max capacity
RV	Give program version
A	Set AUTOZERO function
EV	Set ambient conditions state
EVG	Give set ambient conditions state
FIS	Set filter
FIG	Give current filter setting
ARS	Set value release
ARG	Give current value release setting
LDS	Set last digit
LOGIN	Operator logging
LOGOUT	Operator logout
PROFILES	Profile selection
PRG	Give set profile name
NT	Integration with PUE 7.1, PUE 10 indicator

Caution: Each command must end with CR LF characters.

24.2. Response Format

On receipt of a command, the indicator responds as follows:

XX_A CR LF	command understood and in progress
XX_D CR LF	command carried out (appears only after the XX_A command)
XX_I CR LF	command understood but not accessible at this moment
XX_^ CR LF	command understood but max threshold is exceeded
XX_v CR LF	command understood but min threshold is exceeded
XX_OK CR LF	command carried out
ES_CR LF	command not recognised
XX_E CR LF	time limit exceeded while waiting for stable measurement result (time limit is a characteristic module parameter)

XX - stands for a name of a sent command

_ -space

COMMANDS OVERVIEW

Zeroing

Format: **Z CR LF**

Response options:

- Z_A CR LF - command understood and in progress
- Z_D CR LF - command carried out
- Z_A CR LF - command understood and in progress
- Z_^ CR LF - command understood but zeroing range is exceeded
- Z_A CR LF - command understood and in progress
- Z_E CR LF - time limit exceeded while waiting for stable measurement result
- Z_I CR LF - command understood but not accessible at this moment

Taring

Format: **T CR LF**

Response options:

- T_A CR LF - command understood and in progress
- T_D CR LF - command carried out
- T_A CR LF - command understood and in progress
- T_v CR LF - command understood but taring range is exceeded
- T_A CR LF - command understood and in progress
- T_E CR LF - time limit exceeded while waiting for stable measurement result
- T_I CR LF - command understood but not accessible at this moment

Give tare value

Format: **OT CR LF**

Response: **OT_TARE CR LF** - command carried out

Response format:

1	2	3	4-12	13	14	15	16	17	18	19
O	T	space	Tare	space	unit			space	CR	LF

Tare - 9 characters, right justification

Unit - 3 characters, left justification

Caution:

Tare value is always given in adjustment unit.

Set Tare

Format: **UT_TARE CR LF**, where **TARE** - tare value.

Response options:

- UT_OK CR LF - command carried out
- UT_I CR LF - command understood but not accessible at this moment
- ES CR LF - command not recognised (tare format incorrect)

Caution:

Use dot in tare format as decimal point.

Send stable measurement result in basic measuring unit

Format: **S CR LF**

Response options:

- S_A CR LF - command understood and in progress
- S_E CR LF - time limit exceeded while waiting for stable measurement result
- S_I CR LF - command understood but not accessible at this moment
- MASS FRAME - command carried out, immediate response: mass value in basic measuring unit

Response format:

1	2-3	4	5	6	7-15	16	17	18	19	20	21
S	space	stability marker	space	character	mass	space	unit			CR	LF

Example:

- S CR LF** - command sent from a computer
- S _ A CR LF** - command understood and in progress
- S _ _ _ _ - _ _ _ _ _ 8 . 5 _ g _ _ CR LF** - command carried out, immediate response: mass value in current measuring unit.

where: _ - space

Immediately send measurement result in basic measuring unit

Format: **SI CR LF**

Response options:

- SI_I CR LF - command understood but not accessible at this moment
- MASS FRAME - immediate response: mass value in basic measuring unit

Response format:

1	2	3	4	5	6	7-15	16	17	18	19	20	21
S	I	space	stability marker	space	character	mass	space	unit			CR	LF

Example:

- S I CR LF** - command sent from a computer
- S I _ ? _ _ _ _ _ 1 8 . 5 _ k g _ CR LF** - command carried out, immediate response: mass value in basic measuring unit

where: _ - space

Send stable measurement result in current measuring unit

Format: **SU CR LF**

Response options:

- SU_A CR LF - command understood and in progress
- SU_E CR LF - time limit exceeded while waiting for stable measurement result
- SU_I CR LF - command understood but not accessible at this moment
- MASS FRAME - command carried out, immediate response: mass value in basic measuring unit

Response format:

1	2	3	4	5	6	7-15	16	17	18	19	20	21
---	---	---	---	---	---	------	----	----	----	----	----	----

S	U	space	stability marker	space	character	mass	space	unit	CR	LF
---	---	-------	------------------	-------	-----------	------	-------	------	----	----

Example:

S U CR LF - command sent from a computer

S U _ A CR LF - command understood and in progress

S U _ _ _ - _ _ 1 7 2 . 1 3 5 _ N _ _ CR LF - command carried out, response: mass value in current measuring unit.

where: _ - space

Immediately send measurement result in current measuring unit

Format: **SUI CR LF**

Response options:

SUI_I CR LF - command understood but not accessible at this moment

MASS FRAME - immediate response: mass value in basic measuring unit

Response format:

1	2	3	4	5	6	7-15	16	17	18	19	20	21
S	U	I	stability marker	space	character	mass	space	unit			CR	LF

Example:

S U I CR LF - command sent from a computer

S U I ? _ - _ _ _ 5 8 . 2 3 7 _ k g _ CR LF - command carried out, immediate response: mass value in current measuring unit.

where: _ - space

Switch on continuous transmission in basic measuring unit

Format: **C1 CR LF**

Response options:

C1_I CR LF - command understood but not accessible at this moment

C1_A CR LF - command understood and in progress

MASS FRAME - command carried out, immediate response: mass value in basic measuring unit

Response format:

1	2	3	4	5	6	7-15	16	17	18	19	20	21
S	I	space	stability marker	space	character	mass	space	unit			CR	LF

Switch off continuous transmission in basic measuring unit

Format: **C0 CR LF**

Response options:

C0_I CR LF - command understood but not accessible at this moment

C0_A CR LF - command understood and carried out

Switch on continuous transmission in current measuring unit

Format: **CU1 CR LF**

Response options:

CU1_I CR LF - command understood but not accessible at this moment

CU1_A CR LF - command understood and in progress

MASS FRAME - response: mass value in current measuring unit

Response format:

1	2	3	4	5	6	7-15	16	17	18	19	20	21
S	U	I	stability marker	space	character	mass	space	unit		CR	LF	

Switch off continuous transmission in current measuring unit

Format: **CU0 CR LF**

Response options:

CU0_I CR LF - command understood but not accessible at this moment

CU0_A CR LF - command understood and carried out

Set min checkweighing threshold

Format: **DH_XXXXX CR LF**, where: _ - space, XXXXX - mass format

Response options:

DH_OK CR LF - command carried out

ES CR LF - command not recognised (mass format incorrect)

Set max checkweighing threshold

Format: **UH_XXXXX CR LF**, where: _ - space, XXXXX - mass format

Response options:

UH_OK CR LF - command carried out

ES CR LF - command not recognised (mass format incorrect)

Give value of min checkweighing threshold

Format: **ODH CR LF**

Response: **DH_MASA CR LF** - command carried out

Response format:

1	2	3	4-12	13	14	15	16	17	18	19
D	H	space	mass	space	unit		space	CR	LF	

Mass - 9 characters, right justification

Unit - 3 characters, left justification

Give value of max checkweighing threshold

Format: **OUH CR LF**

Response: **UH_MASA CR LF** - command carried out

Response format:

1	2	3	4-12	13	14	15	16	17	18	19
U	H	space	mass	space	unit		space	CR	LF	

Mass - 9 characters, right justification

Unit - 3 characters, left justification

Set mass value of a single item (for PARTS COUNTING mode)

Format: **SM_XXXXX CR LF**, where: _ - space, XXXXX - mass format

Response options:

- SM_OK CR LF - command carried out
- SM_I CR LF - command understood but not accessible at this moment (e.g. mode other than PARTS COUNTING)
- ES CR LF - command not recognised (mass format incorrect)

Set target mass value (e.g. DOSING mode)

Format: **TV_XXXXX CR LF**, where: _ - space, **XXXXX** - mass format

Response options:

- TV_OK CR LF - command carried out
- TV_I CR LF - command understood but not accessible at this moment (e.g. mode other than DOSING)
- ES CR LF - command not recognised (mass format incorrect)

Set reference mass value (e.g. for PERCENT WEIGHING)

Format: **RM_XXXXX CR LF**, where: _ - space, **XXXXX** - mass format

Response options:

- RM_OK CR LF - command carried out
- RM_I CR LF - command understood but not accessible at this moment (e.g. mode other than PERCENT WEIGHING)
- ES CR LF - command not recognised (mass format incorrect)

Value release

Format: **SS CR LF**

Response options:

- SS_OK CR LF - command understood and in progress

Command's function is similar to function of PRINT key located on the instrument panel.

Internal adjustment

Format: **IC CR LF**

Response options:

- IC_A CR LF - command understood and in progress
- IC_D CR LF - adjustment completed
- IC_A CR LF - command understood and in progress
- IC_E CR LF - time limit exceeded while waiting for stable measurement result
- IC_I CR LF - command understood but not accessible at this moment

Disable automatic internal adjustment of the moisture analyzer

Format: **IC1 CR LF**

Response options:

- IC1_I CR LF - command understood but not accessible at this moment
- IC1_E CR LF - operation not possible, e.g. in case of verified moisture analyzer
- IC1_OK CR LF - command carried out

Operation not possible for verified moisture analyzers.

For non-verified moisture analyzers the command disables internal adjustment until it is enabled via IC0 command or until the moisture analyzer is turned off. The command does not change module settings that concern factors determining adjustment process start.

Enable automatic internal adjustment of the moisture analyzer

Format: **IC0 CR LF**

Response options:

- IC0_I CR LF - command understood but not accessible at this moment

IC0_OK CR LF - command carried out
Operation not possible for verified moisture analyzers.

Give moisture analyzer serial number

Format: **NB CR LF**

Response options:

NB_A_”x” CR LF - command understood, response: serial number

NB_I CR LF - command understood but not accessible at this moment

x – moisture analyzer serial number, inserted in between inverted commas

Example:

Command: NB CR LF - give serial number

Response: NB_A_”1234567” - weighing device serial number --”1234567”

Lock moisture analyzer keypad

Format: **K1 CR LF**

Response options:

K1_I CR LF - command understood but not accessible at this moment

K1_OK CR LF - command carried out

Command locks the moisture analyzer keypad (proximity sensors, touch panel) until the moment of turning the moisture analyzer off or until sending K0 command.

Unlock moisture analyzer keypad

Format: **K0 CR LF**

Response options:

K0_I CR LF - command understood but not accessible at this moment

K0_OK CR LF - command carried out

Give available working modes

Command overview:

Command returns accessible working modes.

Format: **OMI <CR><LF>**

Response options:

OMI <CR><LF>

n_”Mode name” <CR><LF> - command carried out, response: accessible working modes

:

n_”Mode name” <CR><LF>

OK <CR><LF>

OMI_I <CR><LF> - command understood but not accessible at this moment

Mode name – parameter, working mode name, inserted in between inverted commas. The name takes form given on a particular moisture analyzer display, it is provided in a currently selected language.

n - parameter, decimal value determining working mode number.

n → 1 – Weighing

19 – Drying

Caution:

Working modes numbering is identical for each kind of weighing instrument. The numbers are assigned to working modes names.

Some moisture analyzers give only the number as a response.

Example:

Command:	OMI <CR><LF>	- return accessible working modes
Response:	OMI <CR><LF> 19_” Drying” <CR><LF> OK <CR><LF>	- return accessible working modes, mode number + name - command carried out

Set working mode

Command overview:

Command sets particular working mode.

Format: **OMS_n** <CR><LF>

Response options:

OMS_OK<CR><LF>	- command carried out
OMS_E <CR><LF>	- error in-course of command execution, no parameter or incorrect format
OMS_I <CR><LF>	- command understood but not accessible at this moment

n - parameter, decimal value determining working mode number. To see detailed description go to OMI command.

Example:

Command:	OMS_19<CR><LF>	- set DRYING mode
Response:	OMS_OK<CR><LF>	- DRYING mode selected

Give current working mode

Command overview:

Command returns accessible working modes.

Format: **OMG** <CR><LF>

Response options:

OMG_n_OK <CR><LF>	- command carried out, response: current working mode
OMG_I <CR><LF>	- command understood but not accessible at this moment

n - parameter, decimal value determining working mode number. To see detailed description go to OMI command.

Example:

Command:	OMG<CR><LF>	- return current working mode - moisture analyzer set to DRYING mode
Response:	OMG_19_”Drying”OK<CR><LF>	mode

Give accessible units (*weighing mode exclusively*)

Command overview:

Command returns units available for a particular device and for a current working mode.

Format: **UI** <CR><LF>

Response options:

UI_”x₁,x₂, ... x_n”_OK <CR><LF>	- command carried out, returns accessible units
UI_I <CR><LF>	- command understood but not accessible at this moment

X - unit symbols, separated by means of commas

x → g, mg, ct, lb, oz, ozt, dwt, tlh, tls, tlt, tlc, mom, gr, ti, N, baht, tola, u1, u2

Example:

Command: UI <CR><LF> - return available units
Response: UI "g, mg, ct" _OK<CR><LF> - response: available units

Set current unit (*weighing mode exclusively*)

Command overview:

Command sets current unit for a particular device.

Format: **US_x** <CR><LF>

Response options:

US_x_OK <CR><LF> - command carried out, returns accessible units

US_E <CR><LF> - error in-course of command execution, no parameter or incorrect format

US_I <CR><LF> - command understood but not accessible at this moment

x - parameter, units symbols: g, mg, ct, lb, oz, ozt, dwt, tlh, tls, tlt, tlc, mom, gr, ti, N, baht, tola, msg, u1, u2, next

CAUTION:

If x=next the command swaps to another available unit on the list (it simulates  button pressing, or taping unit field in mass window).

Example:

Command: US_mg<CR><LF> - set „mg” unit
Response: US_mg_OK<CR><LF> - „mg” set as a current unit

Give current unit

Command overview:

Command returns current unit.

Format: **UG** <CR><LF>

Response options:

UG_x_OK <CR><LF> - command carried out, returns accessible units

UG_I <CR><LF> - command understood but not accessible at this moment

x - parameter, units symbols:

Example:

Command: UG<CR><LF> - return current unit
Response: UG_ct_OK<CR><LF> - currently set unit is „ct”

Activate sound signal

Command overview:

Command activates BEEP sound signal for a specified amount of time.

Format: **BP_TIME** <CR><LF>

Response options:

BP_OK <CR><LF> - command carried out, BEEP activated

BP_E <CR><LF> - no parameter or incorrect format

BP_I <CR><LF> - command understood but not accessible at this moment

TIME - parameter, decimal value specifying how long shall the sound last, parameter given in [ms]. Recommended range <50÷ 5000>.

If value greater than the permissible high limit is given, then BEEP sound is operated for the maximum permissible amount of time.

Example:

Command: BP_350<CR><LF> - activate BEEP for 350 ms

Response: BP_OK<CR><LF> - BEEP activated

CAUTION:

BEEP sound activated via BP command is inhibited if in-course of its activation the sound is activated by means of other device: keypad, touch panel, proximity sensors.

Send all implemented commands

Format: **PC CR LF**

Command: **PC CR LF** - send all implemented commands

Response: **PC_A_ "Z,T,S,SI..."** - command carried out, the indicator sent all implemented commands.

Give moisture analyzer type

Format: **BN <CR><LF>**

Response options:

BN_A_ "x" <CR><LF> - command understood, response: moisture analyzer type

BN_I <CR><LF> - command understood but not accessible at this moment

x - moisture analyzer type (inserted in between inverted commas), with general moisture analyzer type in front

Example:

Command: BN <CR><LF> - Return moisture analyzer type

Response: BN_A_ "AS" - Moisture analyzer type: "AS R"

Give max capacity

Format: **FS <CR><LF>**

Response options:

FS_A_ "x" <CR><LF> - command understood, response: Max capacity

FS_I <CR><LF> - command understood but not accessible at this moment

x - Max value of reading units (in between inverted commas)

Example:

Command: FS <CR><LF> - Return Max capacity

Response: FS_A_ "220.0000" - Max capacity: "220 g"

Give program version

Format: **RV <CR><LF>**

Response options:

RV_A_ "x" <CR><LF> - command understood, response: program version

RV_I <CR><LF> - command understood but not accessible at this moment

x - program version (in between inverted commas)

Example:

Command: RV <CR><LF> - return program version

Response: RV_A_ " 1.1.1" - program version: "1.1.1"

Set AUTOZERO Function

Format: **A_n <CR><LF>**

Response options:

A_OK <CR><LF> - command carried out
 A_E <CR><LF> - error in-course of command execution, no parameter or incorrect format
 A_I <CR><LF> - command understood but not accessible at this moment
N - parameter, decimal value determining autozero settings:
 n → 0 – autozero off
 1 – autozero on

Caution: Command changes settings for a current working mode.

Example:

Command: A_1<CR><LF> - turn autozero function on

Response: A_OK<CR><LF> - autozero function is on

AUTOZERO function operates until it is turned off by A 0 command.

Set ambient conditions state

Format: **EV_n <CR><LF>**

Response options:

EV_OK <CR><LF> - command carried out

EV_E <CR><LF> - error in-course of command execution, no parameter or incorrect format

EV_I <CR><LF> - command understood but not accessible at this moment

n - parameter, decimal value determining ambient conditions state

n → 0 – unstable ambient conditions

1 – stable ambient conditions

Caution:

Command changes settings for a current working mode.

Example:

Command: EV_1<CR><LF> - set value 'stable' for ambient conditions option

Response: EV_OK<CR><LF> - set value 'stable' for ambient conditions option

<AMBIENT CONDITIONS> parameter is set to value <STABLE> until command EV 0 swaps it to value <UNSTABLE>.

Give set ambient conditions state

Command overview:

Command gives information about state of currently set ambient conditions.

Format: **EVG <CR><LF>**

Response options:

EVG_x_OK<CR><LF> - command carried out, response: set ambient conditions state

EVG_I <CR><LF> - command understood but not accessible at this moment

x - parameter, ambient conditions symbols

Example:

Command: EVG<CR><LF> - give current ambient conditions state

Response: EVG_0_OK<CR><LF> - current ambient conditions state: unstable

Set filter

Format: **FIS_n <CR><LF>**

Response options:

FIS_OK <CR><LF> - command carried out

FIS_E <CR><LF> - error in-course of command execution, no parameter or incorrect

format

FIS_I <CR><LF> - command understood but not accessible at this moment

n - parameter, decimal value determining filter number

- n → 1 – very fast
- 2 – fast
- 3 – average
- 4 – slow
- 5 – very slow

CAUTION:

The numbering is assigned to a particular filter name and it is identical for all moisture analyzer types.

The command changes settings for a current working mode if, for a particular moisture analyzer type, filter settings are assigned to the working mode.

Example:

Command: FIS_3<CR><LF> - set average filter

Response: FIS_OK<CR><LF> - average filter set

Give current filter setting

Command overview:

Command gives information about currently set filter.

Format: **FIG <CR><LF>**

Response options:

FIG_x_OK<CR><LF> - command carried out, response: currently set filter

FIG_I <CR><LF> - command understood but not accessible at this moment

x - parameter, symbol of currently set filter

Example:

Command: FIG<CR><LF> - give current filter

Response: FIG_2_OK<CR><LF> - currently set filter: average

Set value release

Format: **ARS_n <CR><LF>**

Response options:

ARS_OK <CR><LF> - command carried out

ARS_E <CR><LF> - error in-course of command execution, no parameter or incorrect format

ARS_I <CR><LF> - command understood but not accessible at this moment

n - parameter, decimal value determining value release options

- n → 1 – fast
- 2 – fast + reliable
- 3 – reliable

CAUTION:

The numbering is assigned to a particular value release option and it is identical for all moisture analyzer types.

If for a particular moisture analyzer type, last digit settings are assigned to a working mode, the command changes the current mode's settings.

Example:

Command: ARS_2<CR><LF> - set value release parameter to fast+reliable option

Response: ARS_OK<CR><LF> - fast+reliable option set

Give current value release setting

Command overview:

Command gives information about current value release setting.

Format: **ARG <CR><LF>**

Response options:

ARG_x_OK<CR><LF> - command carried out, response: current value release setting

ARG_I <CR><LF> - command understood but not accessible at this moment

x - parameter, symbol of current value release setting

Example:

Command: ARG<CR><LF> - give current value release setting

Response: ARG_2_OK<CR><LF> - current value release setting: fast+reliable

Set last digit

Format: **LDS_n <CR><LF>**

Response options:

LDS_OK<CR><LF> - command carried out

LDS_E <CR><LF> - error in-course of command execution, no parameter or incorrect format

LDS_I <CR><LF> - command understood but not accessible at this moment

n - parameter, decimal value determining last digit settings

n → 1 – always

2 – never

3 – when stable

CAUTION:

The numbering is assigned to a particular last digit option and it is identical for all moisture analyzer types.

If for a particular moisture analyzer type, last digit settings are assigned to a working mode, the command changes the current mode's settings.

Example:

Command: LDS_1<CR><LF> - set last digit option to value 'always'

Response: LDS_OK<CR><LF> - 'always' value set

Operator logging

Format: **LOGIN_Name, Password CR LF** where: _ - space

(enter name and password in a form provided by the moisture analyzer – lower-case letters and upper-case letters)

Response options:

LOGIN OK CR LF - command understood, new operator logged in

LOGIN ERROR CR LF - command understood, an error in name or password occurred, log in failed

ES CR LF - command not recognized (error in format)

Operator logout

Format: **LOGOUT CR LF**

Response options:

LOGOUT OK CR LF - command understood, user is logged out

ES CR LF - command not recognized (error in format)

Give set profile name

Format: **PRG CR LF**

Response options:

PRG_A_”x” CR LF - command understood, response: profile name

PRG_I CR LF - command understood but not accessible at this moment

x - profile name (in between inverted commas)

Example:

Command: **PRG CR LF** - give profile name

Response: **PRG _A_”Fast”** – profile name --”Fast”

Profile selection

Format: **PROFILE_Name CR LF**

where: _ - space (enter name in a form provided by the moisture analyzer – *lower-case letters and upper-case letters, spaces; e.g. Fast; Fast dosing, User, Precision*).

Response options:

PROFILE OK CR LF - command understood, new profile set

LOGIN ERROR CR LF - command understood, an error in name, profile setting impossible

ES CR LF - command not recognized (error in format)

Give set profile name

Format: **PRG CR LF**

Response options:

PRG_A_”x” CR LF - command understood, response: profile name

PRG_I CR LF - command understood but not accessible at this moment

x - profile name (in between inverted commas)

Example:

Command: **PRG CR LF** - give profile name

Response: **PRG _A_”Fast”** – profile name --”Fast”

Profile selection

Format: **PROFILE_Name CR LF**

where: _ - space (enter name in a form provided by the moisture analyzer – *lower-case letters and upper-case letters, spaces; e.g. Fast; Fast dosing, User, Precision*).

Response options:

PROFILE OK CR LF - command understood, new profile set

LOGIN ERROR CR LF - command understood, an error in name, profile setting impossible

ES CR LF - command not recognized (error in format)

Integration with PUE 7.1, PUE 10 indicator

Format: **NT CR LF**

Response options:

ES CR LF - command not recognised (mass format incorrect)

MASS FRAME - command carried out, immediate response: mass value in basic measuring unit

Response format:

1	2	3	4	5	6	7	8	9-18	19	20-22	23	24-32	33	34-36	37	38	39	40
N	T	space	Stability marker	Zero marker	Range marker	Digit marker	space	Mass	space	Mass unit	space	tare	space	Tare unit	space	Hidden digits quantity	CR	LF

NT - Command

Stability marker - [space] if stable, [?] if unstable

Zero marker - [space] for any value but zero, [Z] for zero value

Range marker - marker informing on range within which mass value is comprised: [space] I range balance, [2] II balance, [3] III balance

Digit marker - [zero] no digit, [1] one digit marker, [2] two digits marker, [3] three digits marker, [4] four digits marker, [5] five digits marker

Mass - 10 characters for net mass given in adjustment unit (with dot and a floating-point “-“ sign) with right justification

Mass unit - 3 characters, left justification

Tare - 9 characters with dot - right justification (when floating-point tare gets turned off automatically then zero value is sent)

Tare unit - 3 characters, left justification

Hidden digits quantity - number specifying quantity of hidden digits: [space] when no digits are hidden, [1] when 1 digit is hidden

Example:

NT CR LF - command sent from a computer

NT _ ? _ _ 0 _ _ _ _ - 5 . 1 1 3 _ g _ _ _ _ _ 0 . 0 0 0 _ g _ _ _ 0 CR LF

- command carried out, response: mass value and remaining data

where: _ - space

24.3. Manual Printout / Automatic Printout

The moisture analyzer enables generating manual or automatic printouts.

- Manual printout: upon indication stabilization press  key.
- Automatic printout is generated automatically in accordance with the settings for automatic printout (read section 9).

The content of printout depends on settings of <Standard printout> menu - <GLP Printout> (read section 12.3).

Mass printout format:

1	2	3	4 -12	13	14	15	16	17	18
stability marker	space	stability	mass	space	unit			CR	LF

Stability marker [space] if stable
 [?] if unstable
 [^] if high limit is out of range
 [v] if low limit is out of range
 Character [space] for positive values
 [-] for negative values
 Mass 9 characters with decimal point, right justification
 Unit 3 characters, left justification

Example:

_____ **1 8 3 2 . 0 _ g _ _ CR LF** - a printout generated, with reference to <GLP printout> settings, from a weighing device upon pressing  key:

Date	NO	Universal variable 3	NO
Time	NO	NET	NO
Operator	NO	Tare	NO
Product	NO	Gross	NO
Customer	NO	Current result	YES
Packaging	NO	Adjustment report	NO
Universal variable 1	NO	Non-standard printout	NONE
Universal variable 2	NO		

25. PERIPHERAL DEVICES

The weighing instrument can cooperate with the following peripheral devices:

- computer,
- EPSON labeller,
- PCL printer,
- an optional peripheral device operating ASCII communication protocol.

26. ERROR MESSAGES



Max weighing threshold exceeded
Unload the weighing pan



Min weighing threshold exceeded
Install weighing pan



Zeroing out of range
Press tarring button or restart the balance



Display capacity out of range
Unload the weighing pan



Tarring out of range
Press zeroing button or restart the balance



Start mass out of range
Install weighing pan



Zeroing/tarring time out of range
Weighing indication unstable

27. MOISTURE ANALYZER MEANS OF OPERATION

For measurement temperatures ranging from 161°C to 250°C the time of maintaining the temperature during the measurement is estimated proportionally, ~15 hours for 161°C – 10 min for 250°C.

For a drying process carried out in 250°C, Max temp is maintained for 10 min, next the program automatically lowers the temperature (drying is not interrupted) to 160°C.

Lowering temperature to 160°C takes ~10 min.

For QUICK drying mode Max drying temperature remanipulation is 30% but no more than Max temperature for a particular moisture analyzer.

28. MAINTENANCE ACTIVITIES

This section describes how to maintain the moisture analyzer in good condition, and how to replace its faulty components (filaments, fuses).

Caution:

In case of heavy dust occurring at the place of moisture analyzer operation, it is recommended to commission an inspection of the device to be carried out by RADWAG service every 6 months.

28.1. Cleaning Moisture Analyzer Components

In order to ensure required measuring accuracy, the moisture analyzer has to be used and stored clean.

While cleaning the moisture analyzer, obey precautions provided in this section.

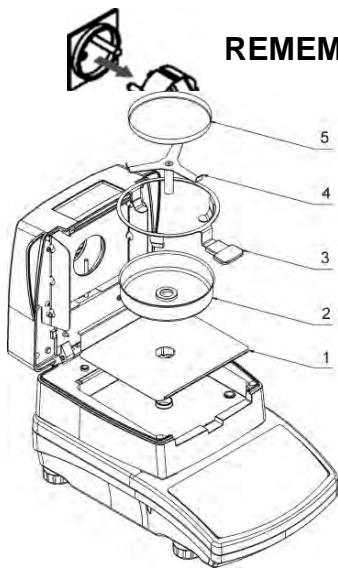

REMEMBER– before initiating any maintenance or cleaning activities switch off the moisture analyzer and make sure the power cord is unplugged from the mains!

Any residue of the dried material that has fallen off the weighing pan and is inside the drying chamber may ignite during subsequent drying. Make sure the drying chamber is clean.

Open moisture analyzer's cover and take out all components of the drying chamber: disposable pan, weighing pan handle, cross-shaped holder, weighing pan shield, drying chamber base insert. During maintenance activities follow the description from section 4.5 of this user manual.

Upon cleaning let the subassemblies dry.

Make sure no liquids or dirt get inside the drying chamber.

Install clean components following the diagram.

28.2. Cleaning Temperature Sensor

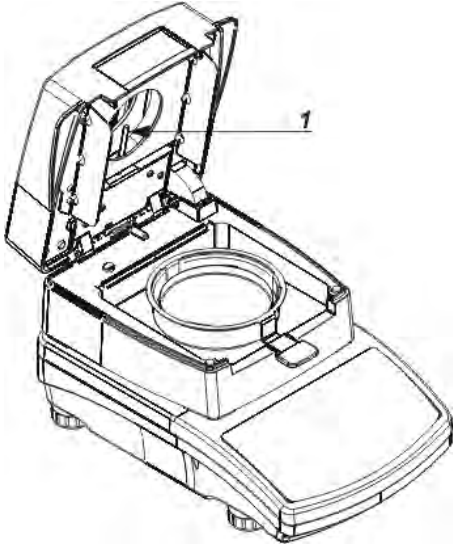

To ensure correct temperature measurement make sure that the temperature sensor is clean (1).

Take extra precautions while cleaning the device.

Clean the moisture analyzer using soft fabrics and mild cleaning agents. Do not use any abrasive agents or solvents as it may cause damage to the sensor.

Neither IR emitter nor halogen shall be touched in the course of cleaning activities, this is to prevent risk of damage.

It is possible to clean emitter's shields if there is such a necessity. To do that, use soft fabrics exclusively. Remember not to touch the emitters.

Remember to verify the temperature sensor indication correctness at least twice a year. If required, carry out sensor calibration. For detailed information read

ADJUSTMENT section.

28.3. Troubleshooting

Problem: no reaction to pressing main switch on/off key (display remains dark).

Probable cause:

- no voltage in the mains,
- damaged power cord,
- damaged fuse of the moisture analyzer,
- damaged moisture analyzer.

Problem: too long pending time for drying process finish.

Probable cause:

- - incorrect finish mode selected - select it experimentally

Problem: lack of measurements repeatability

Probable cause:

- non-uniform sample content – prepare the sample using larger amount of substance.
- the drying time is too short – change finish mode.
- drying temperature is too high, causing sample's oxidizing - lower drying temperature.
- tested sample boils - lower drying temperature.
- the temperature sensor is contaminated or defected - clean the temperature sensor.
- the weighing table on which the moisture analyzer is located is unstable - move the device to a different workstation.
- the ambient area is incompatible with the requirements (vibrations, drafts, etc.) - change the ambient conditions for compatible ones according to the guidelines of this service manual.

29. ACCESSORIES

Type	Name
P0151	RS232 cable for EPSON printer
EPSON	Dot/thermal printer
	PCL printer
SAL	Anti-vibration table
	PC keyboard – USB type

30. MOISTURE ANALYZER INFO

Moisture analyzer info menu provides information on moisture analyzer and its software. Parameters serve information purposes only.



← Informacje o wadze	
Id wagi	123455
Typ wagi	AS
Wersja programu	2.0.0
Kod produktu	123456789012
Wydruk ustawień	

In order to send moisture analyzer settings (all parameters) to printer port, select <Settings printout> parameter.

*User manual number:
IMMU-21-15-06-20-EN*



RADWAG BALANCES AND SCALES
ADVANCED WEIGHING TECHNOLOGIES

